

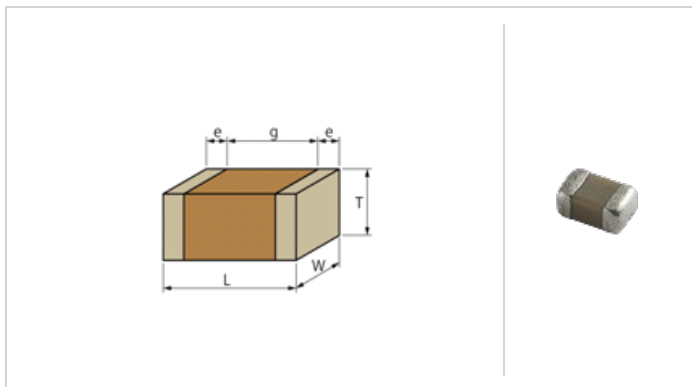

< List of part numbers with package codes >
GCJ32DR72J223KXJ1L , GCJ32DR72J223KXJ1K

Shape



L size	3.2 ±0.3mm
W size	2.5 ±0.2mm
T size	2.0 +0.0/-0.3mm
External terminal width e	0.3mm min.
Distance between external terminals g	1.2mm min.
Size code in inch(mm)	1210 (3225M)

Notes

Resin external electrode products

References

Packaging	Specifications	Minimum quantity
L	φ180mm Embossed taping	1000
K	φ330mm Embossed taping	4000

Mass (typ.)	
1 piece	95mg
φ180mm Reel	123g

Specifications

Capacitance	22000pF ±10%
Rated voltage	630Vdc
Temperature characteristics (complied standard)	X7R(EIA)
Capacitance change rate	±15.0%
Temperature range of temperature characteristics	-55 to 125°C
Operating temperature range	-55 to 125°C

Attention

- 1.This datasheet is downloaded from the website of Murata Manufacturing Co., Ltd. Therefore, it's specifications are subject to change or our products in it may be discontinued without advance notice. Please check with our sales representatives or product engineers before ordering.
- 2.This datasheet has only typical specifications because there is no space for detailed specifications. Therefore, please review our product specifications or consult the approval sheet for product specifications before ordering.