

RF Power LDMOS Transistor

N-Channel Enhancement-Mode Lateral MOSFET

Designed primarily for CW large-signal output and driver applications with frequencies up to 450 MHz. Device is unmatched and is suitable for use in aerospace and defense applications.

- Typical CW Performance at 220 MHz: $V_{DD} = 50$ Vdc, $I_{DQ} = 30$ mA, $P_{out} = 10$ W
 Power Gain — 23.9 dB
 Drain Efficiency — 62%
- Capable of Handling 10:1 VSWR @ 50 Vdc, 220 MHz, 10 W CW Output Power

Features

- Characterized with Series Equivalent Large-Signal Impedance Parameters
- Qualified Up to a Maximum of 50 V_{DD} Operation
- Integrated ESD Protection
- 225°C Capable Plastic Package
- In Tape and Reel. R1 Suffix = 500 Units, 24 mm Tape Width, 13-inch Reel.

MMRF1012NR1

**10-450 MHz, 10 W, 50 V
 BROADBAND
 RF POWER MOSFET**

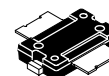

**TO-270-2
 PLASTIC**

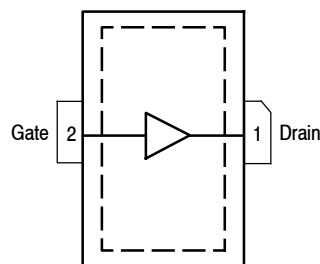

(Top View)

Note: Exposed backside of the package is the source terminal for the transistor.

Figure 1. Pin Connections

Table 1. Maximum Ratings

Rating	Symbol	Value	Unit
Drain-Source Voltage	V_{DSS}	-0.5, +120	Vdc
Gate-Source Voltage	V_{GS}	-0.5, +10	Vdc
Storage Temperature Range	T_{stg}	- 65 to +150	°C
Case Operating Temperature	T_C	150	°C
Operating Junction Temperature (1,2)	T_J	225	°C

Table 2. Thermal Characteristics

Characteristic	Symbol	Value (2,3)	Unit
Thermal Resistance, Junction to Case Case Temperature 81°C, 10 W CW	$R_{\theta JC}$	3.0	°C/W

1. Continuous use at maximum temperature will affect MTTF.
2. MTTF calculator available at <http://www.freescale.com/rf>. Select Software & Tools/Development Tools/Calculators to access MTTF calculators by product.
3. Refer to AN1955, *Thermal Measurement Methodology of RF Power Amplifiers*. Go to <http://www.freescale.com/rf>. Select Documentation/Application Notes - AN1955.

Table 3. ESD Protection Characteristics

Test Methodology	Class
Human Body Model (per JESD22-A114)	2
Machine Model (per EIA/JESD22-A115)	A
Charge Device Model (per JESD22-C101)	IV

Table 4. Moisture Sensitivity Level

Test Methodology	Rating	Package Peak Temperature	Unit
Per JESD22-A113, IPC/JEDEC J-STD-020	3	260	°C

Table 5. Electrical Characteristics ($T_A = 25^\circ\text{C}$ unless otherwise noted)

Characteristic	Symbol	Min	Typ	Max	Unit
----------------	--------	-----	-----	-----	------

Off Characteristics

Gate-Source Leakage Current ($V_{GS} = 5\text{ Vdc}$, $V_{DS} = 0\text{ Vdc}$)	I_{GSS}	—	—	10	μAdc
Drain-Source Breakdown Voltage ($I_D = 5\text{ mA}$, $V_{GS} = 0\text{ Vdc}$)	$V_{(BR)DSS}$	120	—	—	Vdc
Zero Gate Voltage Drain Leakage Current ($V_{DS} = 50\text{ Vdc}$, $V_{GS} = 0\text{ Vdc}$)	I_{DSS}	—	—	50	μAdc
Zero Gate Voltage Drain Leakage Current ($V_{DS} = 100\text{ Vdc}$, $V_{GS} = 0\text{ Vdc}$)	I_{DSS}	—	—	2.5	mA

On Characteristics

Gate Threshold Voltage ($V_{DS} = 10\text{ Vdc}$, $I_D = 28\ \mu\text{Adc}$)	$V_{GS(th)}$	1	1.68	3	Vdc
Gate Quiescent Voltage ($V_{DD} = 50\text{ Vdc}$, $I_D = 30\text{ mAdc}$, Measured in Functional Test)	$V_{GS(Q)}$	1.5	2.68	3.5	Vdc
Drain-Source On-Voltage ($V_{GS} = 10\text{ Vdc}$, $I_D = 70\text{ mAdc}$)	$V_{DS(on)}$	—	0.26	—	Vdc

Dynamic Characteristics

Reverse Transfer Capacitance ($V_{DS} = 50\text{ Vdc} \pm 30\text{ mV(rms)ac}$ @ 1 MHz, $V_{GS} = 0\text{ Vdc}$)	C_{rss}	—	0.13	—	pF
Output Capacitance ($V_{DS} = 50\text{ Vdc} \pm 30\text{ mV(rms)ac}$ @ 1 MHz, $V_{GS} = 0\text{ Vdc}$)	C_{oss}	—	7.3	—	pF
Input Capacitance ($V_{DS} = 50\text{ Vdc}$, $V_{GS} = 0\text{ Vdc} \pm 30\text{ mV(rms)ac}$ @ 1 MHz)	C_{iss}	—	16.3	—	pF

Functional Tests (In Freescale Test Fixture, 50 ohm system) $V_{DD} = 50\text{ Vdc}$, $I_{DQ} = 30\text{ mA}$, $P_{out} = 10\text{ W}$, $f = 220\text{ MHz}$, CW

Power Gain	G_{ps}	22.5	23.9	25.5	dB
Drain Efficiency	η_D	58	62	—	%
Input Return Loss	IRL	—	-14	-9	dB



ATTENTION: The MMRF1012N is a high power device and special considerations must be followed in board design and mounting. Incorrect mounting can lead to internal temperatures which exceed the maximum allowable operating junction temperature. Refer to Freescale Application Note AN1907 (for solder reflow mounting) **PRIOR TO STARTING SYSTEM DESIGN** to ensure proper mounting of this device.

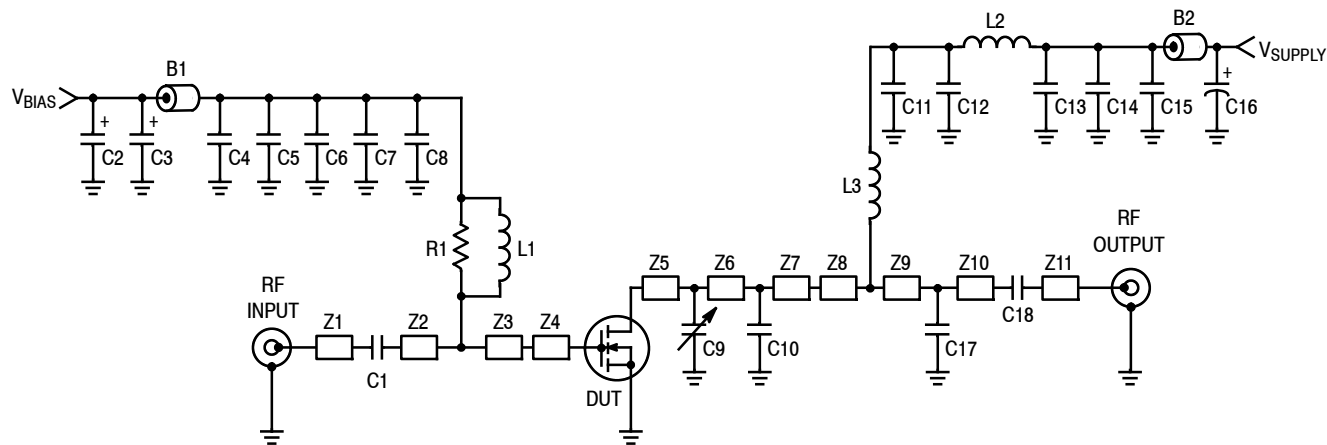

Z1	0.235" x 0.082" Microstrip	Z7	0.062" x 0.270" Microstrip
Z2	1.190" x 0.082" Microstrip	Z8	0.198" x 0.082" Microstrip
Z3	0.619" x 0.082" Microstrip	Z9	5.600" x 0.082" Microstrip
Z4	0.190" x 0.270" Microstrip	Z10	0.442" x 0.082" Microstrip
Z5	0.293" x 0.270" Microstrip	Z11	0.341" x 0.082" Microstrip
Z6	0.120" x 0.270" Microstrip	PCB	Arlon CuClad 250GX-0300-55-22, 0.030", $\epsilon_r = 2.55$

Figure 2. MMRF1012NR1 Test Circuit Schematic

Table 6. MMRF1012NR1 Test Circuit Component Designations and Values

Part	Description	Part Number	Manufacturer
B1, B2	95 Ω , 100 MHz Long Ferrite Beads	2743021447	Fair-Rite
C1, C8, C11, C18	1000 pF Chip Capacitors	ATC100B102JT50XT	ATC
C2	10 μ F, 35 V Tantalum Capacitor	T491D106K035AT	Kemet
C3	22 μ F, 35 V Tantalum Capacitor	T491X226K035AT	Kemet
C4, C13	39 K pF Chip Capacitors	ATC200B393KT50XT	ATC
C5, C14	22 K pF Chip Capacitors	ATC200B223KT50XT	ATC
C6, C15	0.1 μ F Chip Capacitors	CDR33BX104AKYS	Kemet
C7, C12	2.2 μ F, 50 V Chip Capacitors	C1825C225J5RAC	Kemet
C9	0.6-4.5 pF Variable Capacitor, Gigatrim	27271SL	Johanson
C10	12 pF Chip Capacitor	ATC100B120JT500XT	ATC
C16	470 μ F, 63 V Electrolytic Capacitor	ESMG630ELL471MK205	United Chemi-Con
C17	27 pF Chip Capacitor	ATC100B270JT500XT	ATC
L1	17.5 nH Inductor	B06T	CoilCraft
L2, L3	82 nH Inductors	1812SMS-82NJ	CoilCraft
R1	120 Ω , 1/4 W Chip Resistor	CRCW1206120RFKEA	Vishay

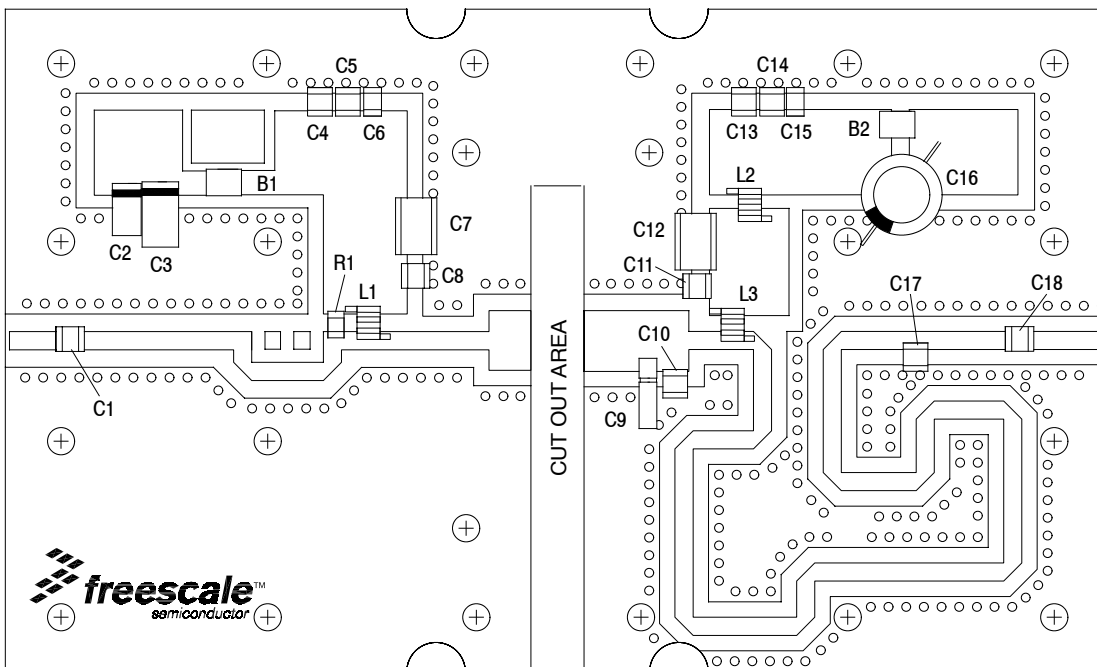

Figure 3. MMRF1012NR1 Test Circuit Component Layout

TYPICAL CHARACTERISTICS

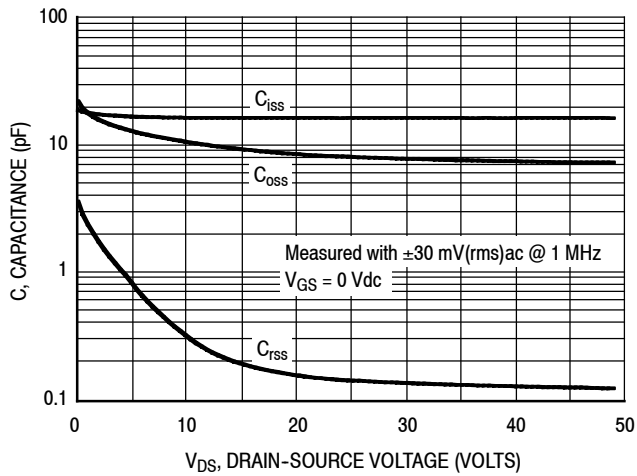

Figure 4. Capacitance versus Drain-Source Voltage

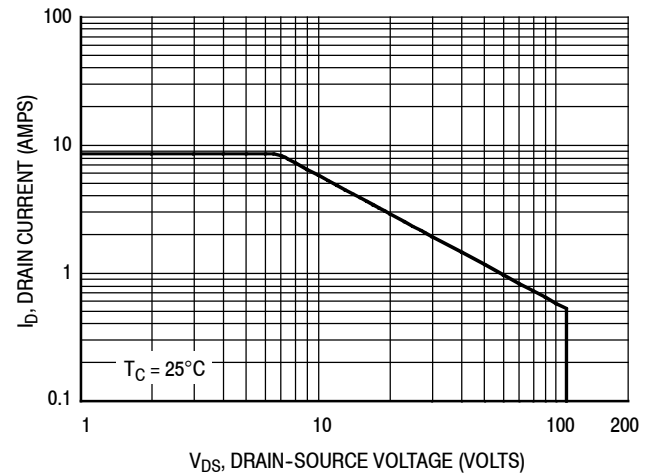

Figure 5. DC Safe Operating Area

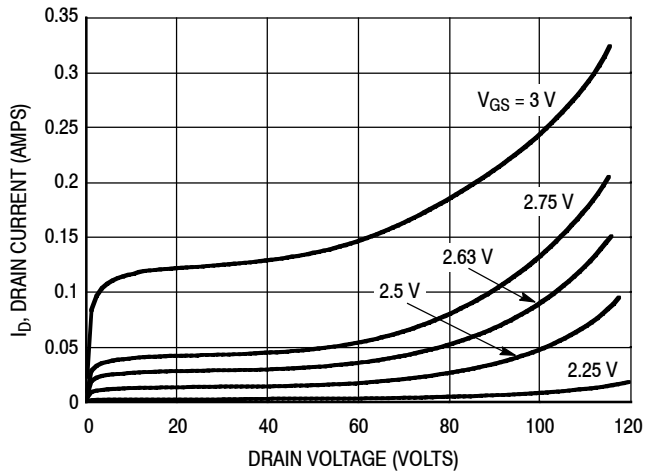

Figure 6. DC Drain Current versus Drain Voltage

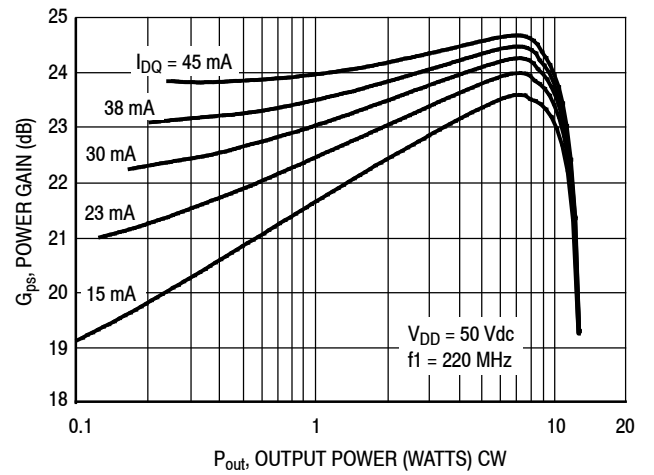

Figure 7. CW Power Gain versus Output Power

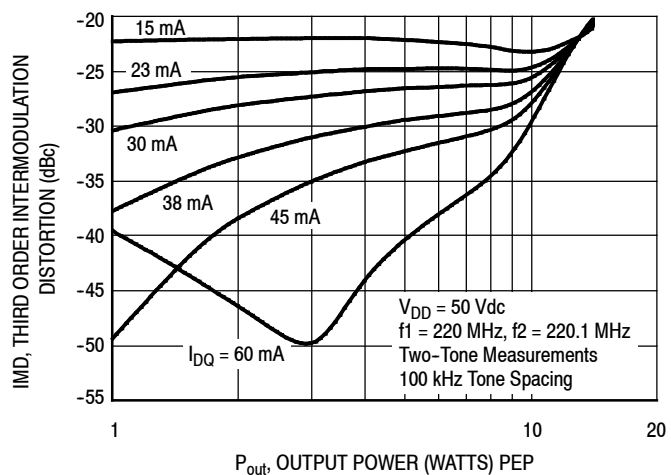

Figure 8. Third Order Intermodulation Distortion versus Output Power

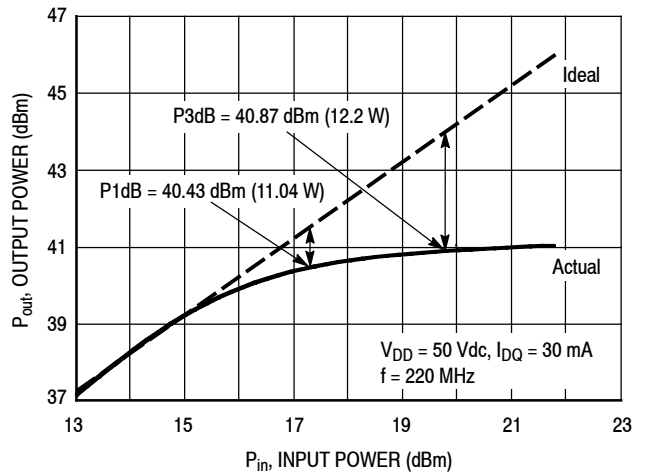

Figure 9. CW Output Power versus Input Power

TYPICAL CHARACTERISTICS

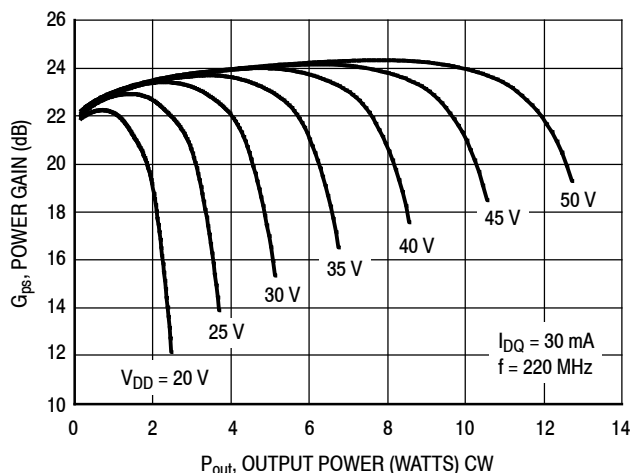

Figure 10. Power Gain versus Output Power

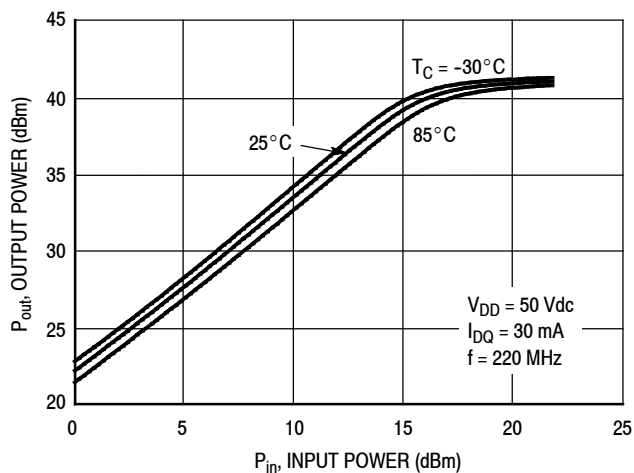

Figure 11. Power Output versus Power Input

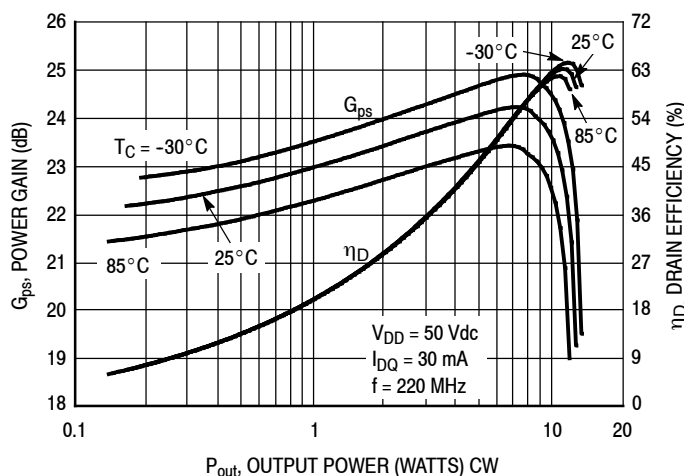

Figure 12. Power Gain and Drain Efficiency versus CW Output Power

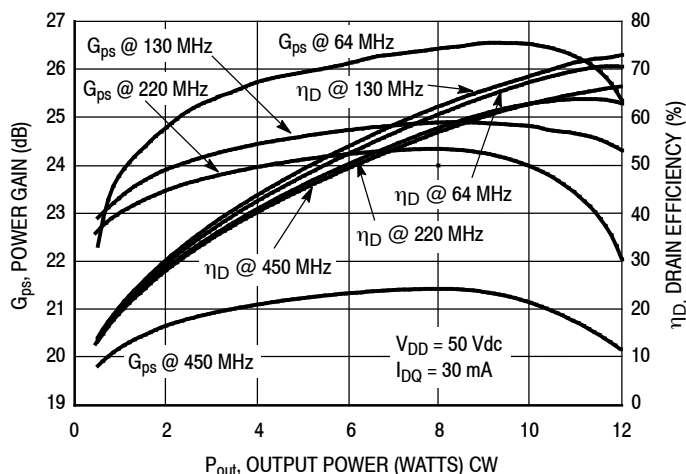
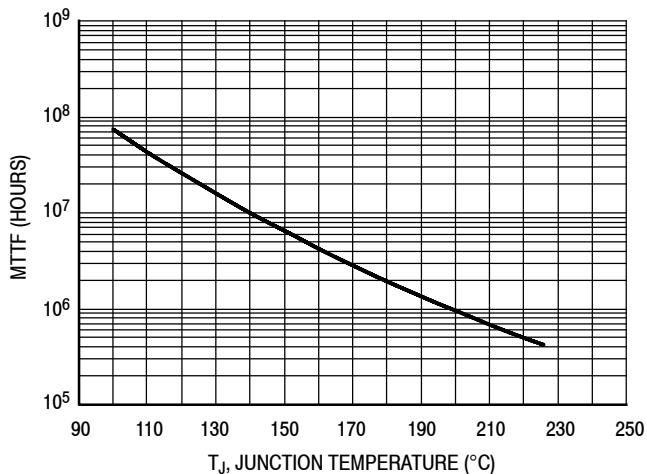

Figure 13. Power Gain and Drain Efficiency versus CW Output Power



This above graph displays calculated MTTF in hours when the device is operated at $V_{DD} = 50$ Vdc, $P_{out} = 10$ W CW, and $\eta_D = 62\%$.

MTTF calculator available at <http://www.freescale.com/rf>. Select Software & Tools/Development Tools/Calculators to access MTTF calculators by product.

Figure 14. MTTF versus Junction Temperature — CW

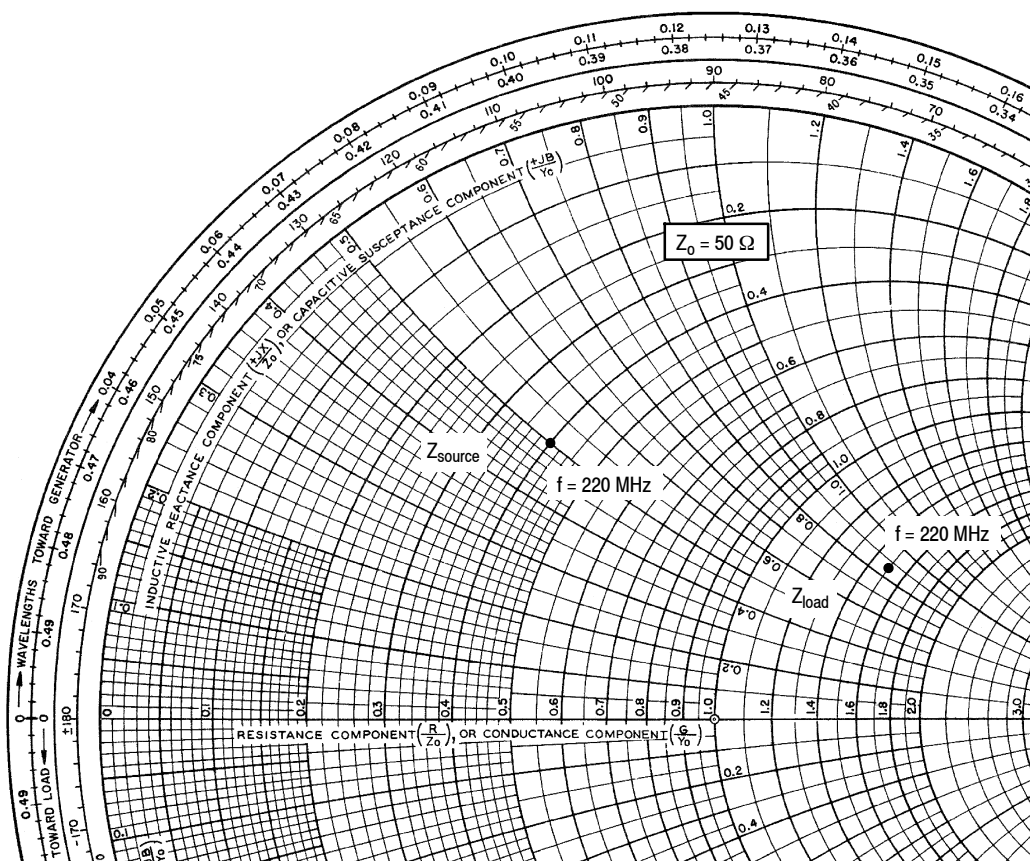

$V_{DD} = 50 \text{ Vdc}$, $I_{DQ} = 30 \text{ mA}$, $P_{out} = 10 \text{ W CW}$

f MHz	Z_{source} Ω	Z_{load} Ω
220	$20 + j25$	$75 + j44$

Z_{source} = Test circuit impedance as measured from gate to ground.

Z_{load} = Test circuit impedance as measured from drain to ground.

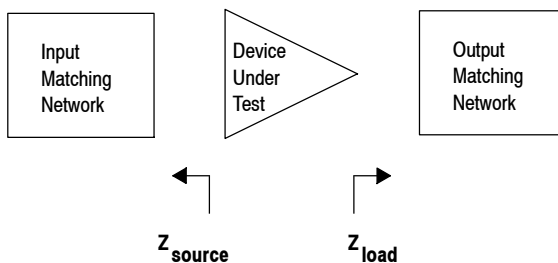

Figure 15. Series Equivalent Source and Load Impedance

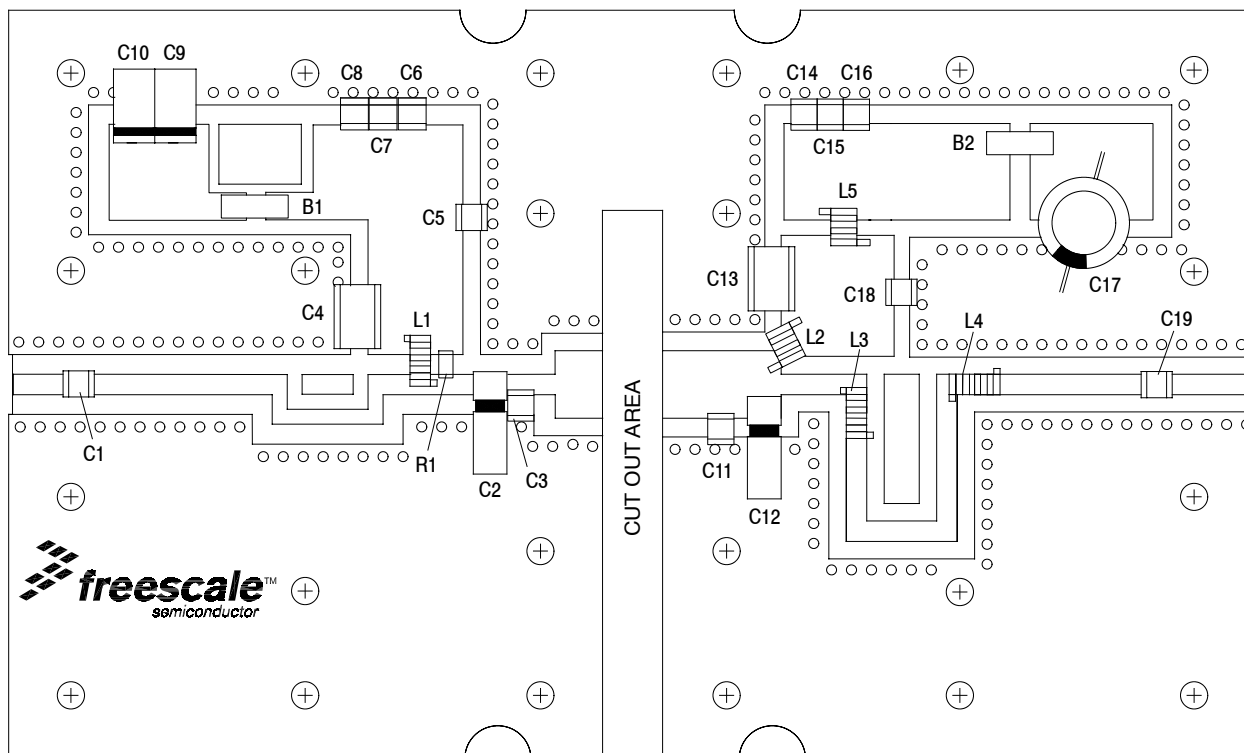

Figure 16. MMRF1012NR1 Test Circuit Component Layout — 130 MHz

Table 7. MMRF1012NR1 Test Circuit Component Designations and Values — 130 MHz

Part	Description	Part Number	Manufacturer
B1, B2	95 Ω , 100 MHz Long Ferrite Beads, Surface Mount	2743021447	Fair-Rite
C1, C5, C18, C19	1000 pF Chip Capacitors	ATC100B102JT50XT	ATC
C2, C12	0.6–4.5 pF Variable Capacitors, Gigatrim	27271SL	Johanson
C3	27 pF Chip Capacitor	ATC100B270JT500XT	ATC
C4, C13	2.2 μ F, 50 V Chip Capacitors	C1825C225J5RAC	Kemet
C6, C14	0.1 μ F, 50 V Chip Capacitors	CDR33BX104AKYM	Kemet
C7, C15	22K pF Chip Capacitors	ATC200B223KT50XT	ATC
C8, C16	39K pF Chip Capacitors	ATC200B393KT50XT	ATC
C9	22 μ F, 35 V Tantalum Capacitor	T491X226K035AT	Kemet
C10	10 μ F, 35 V Tantalum Capacitor	T491D106K035AT	Kemet
C11	16 pF Chip Capacitor	ATC100B160JT500XT	ATC
C17	330 μ F, 63 V Electrolytic Capacitor	MCRH63V337M13X21-RH	Multicomp
L1	17.5 nH Inductor	B06T	CoilCraft
L2, L5	82 nH Inductors	1812SMS-82NJ	CoilCraft
L3	35.5 nH Inductor	B09T	CoilCraft
L4	43 nH Inductor	B10T	CoilCraft
R1	100 Ω , 1/4 W Chip Resistor	CRCW1206100RFKEA	Vishay
PCB	0.030", $\epsilon_r = 2.55$	CuClad 250GX-0300-55-22	Arlon

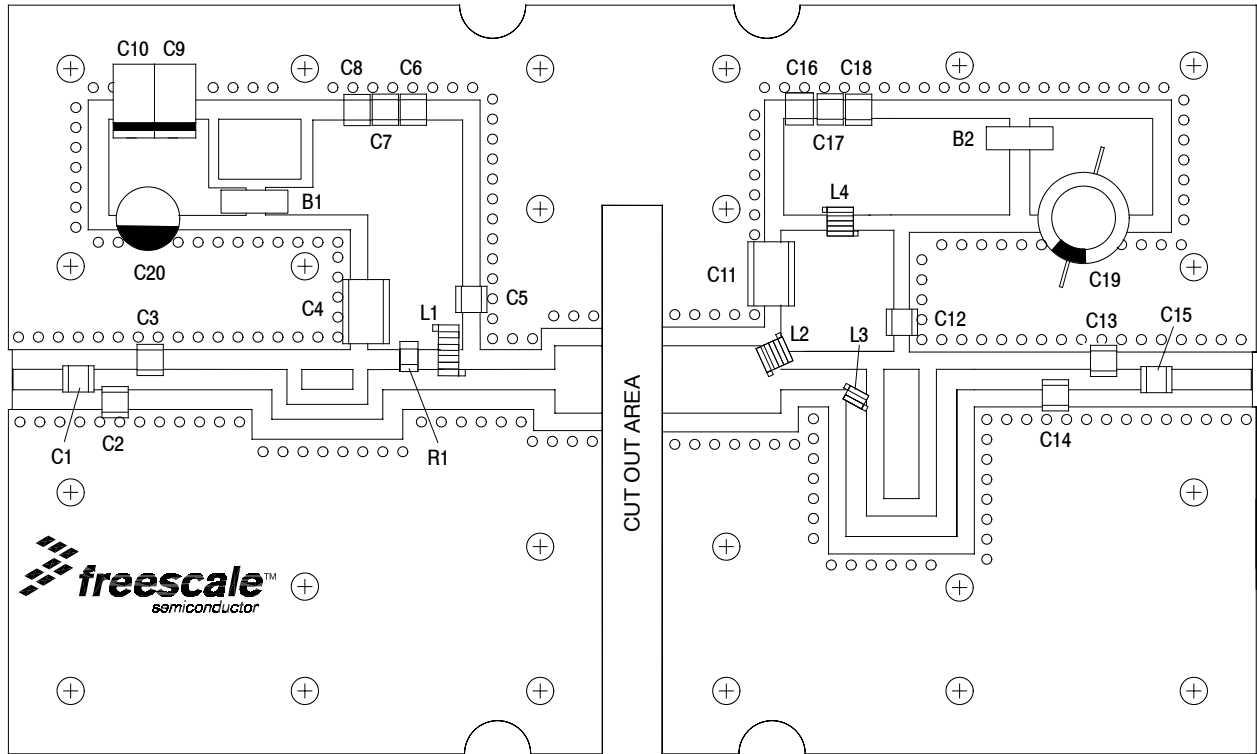

Figure 17. MMRF1012NR1 Test Circuit Component Layout — 450 MHz

Table 8. MMRF1012NR1 Test Circuit Component Designations and Values — 450 MHz

Part	Description	Part Number	Manufacturer
B1, B2	95 Ω , 100 MHz Long Ferrite Beads, Surface Mount	2743021447	Fair-Rite
C1, C5, C12, C15	240 pF Chip Capacitors	ATC100B241JT200XT	ATC
C2, C3	10 pF Chip Capacitors	ATC100B100JT500XT	ATC
C4, C11	2.2 μ F, 50 V Chip Capacitors	C1825C225J5RAC	Kemet
C6, C16	0.1 μ F 50V Chip Capacitors	CDR33BX104AKYM	Kemet
C7, C17	22K pF Chip Capacitors	ATC200B223KT50XT	ATC
C8, C18	39K pF Chip Capacitors	ATC200B393KT50XT	ATC
C9	22 μ F, 35 V Tantalum Capacitor	T491X226K035AT	Kemet
C10	10 μ F, 35 V Tantalum Capacitor	T491D106K035AT	Kemet
C13, C14	6.2 pF Chip Capacitors	ATC100B6R2BT500XT	ATC
C19	470 μ F, 63 V Electrolytic Capacitor	MCGPR63V477M13X26-RH	Multicomp
C20	47 μ F, 50 V Electrolytic Capacitor	476KXM050M	Illinois Cap
L1	17.5 nH Inductor	B06T	CoilCraft
L2, L4	82 nH Inductors	1812SMS-82NJ	CoilCraft
L3	5.0 nH Inductor	A02T	CoilCraft
R1	120 Ω , 1/4 W Chip Resistor	CRCW1206120RFKEA	Vishay
PCB	0.030", $\epsilon_r = 2.55$	CuClad 250GX-0300-55-22	Arlon

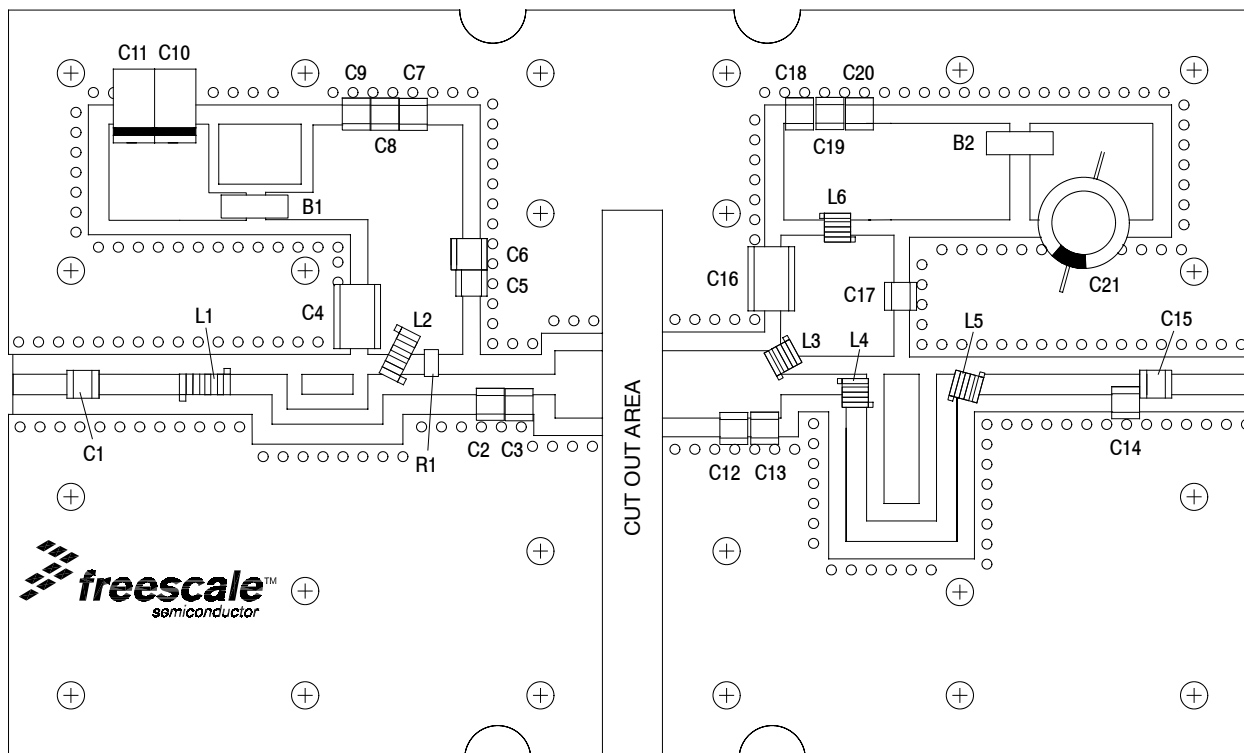
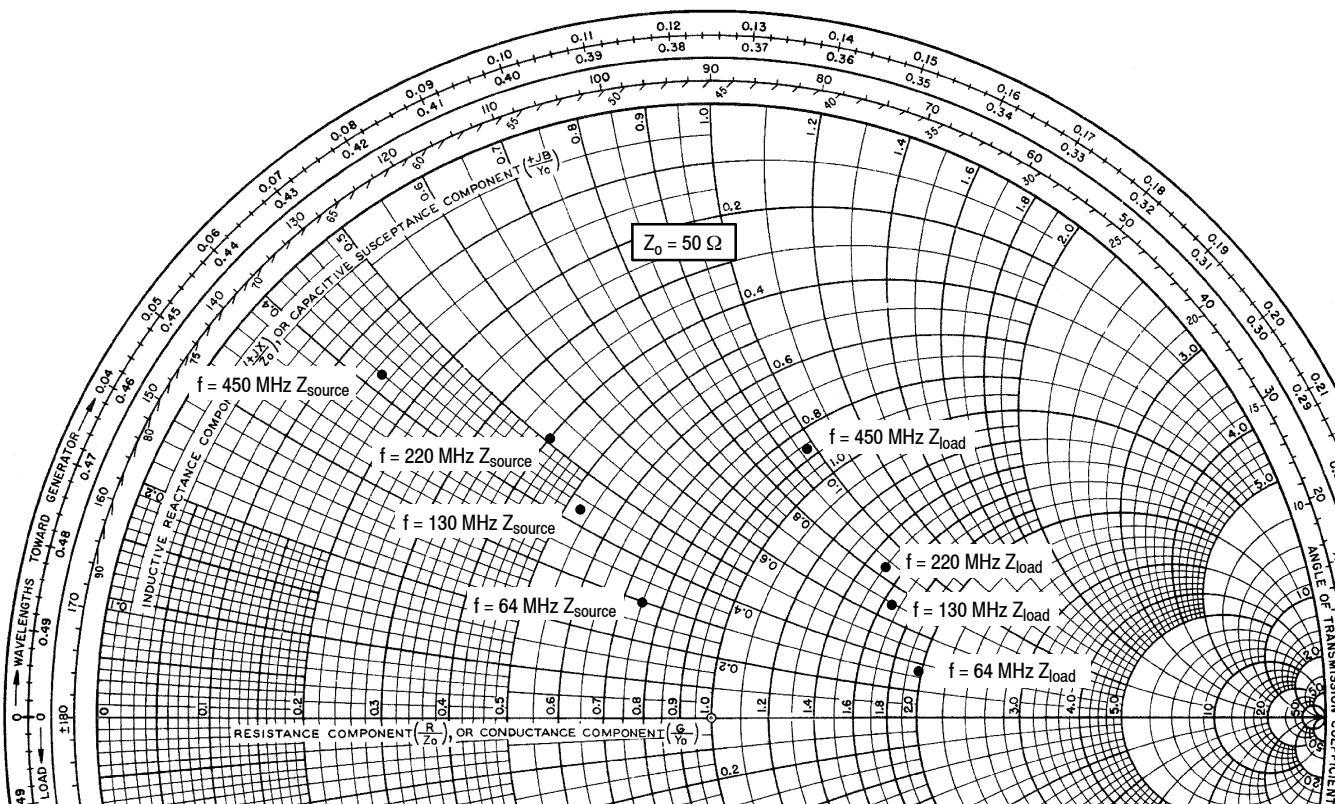

Figure 18. MMRF1012NR1 Test Circuit Component Layout — 64 MHz

Table 9. MMRF1012NR1 Test Circuit Component Designations and Values — 64 MHz

Part	Description	Part Number	Manufacturer
B1, B2	95 Ω , 100 MHz Long Ferrite Beads, Surface Mount	2743021447	Fair-Rite
C1, C5, C15, C17	1000 pF Chip Capacitors	ATC100B102JT50XT	ATC
C2	91 pF Chip Capacitor	ATC100B910JT500XT	ATC
C3, C14	22 pF Chip Capacitors	ATC100B220JT500XT	ATC
C4, C16	2.2 μ F, 50 V Chip Capacitors	C1825C225J5RAC	Kemet
C6	220 nF, 50 V Chip Capacitor	C1812C224J5RAC	Kemet
C7, C18	0.1 μ F, 50 V Chip Capacitors	CDR33BX104AKYM	Kemet
C8, C19	100K pF Chip Capacitors	ATC200B104KT50XT	ATC
C9, C20	22K pF Chip Capacitors	ATC200B223KT50XT	ATC
C10	22 μ F, 35 V Tantalum Capacitor	T491X226K035AT	Kemet
C11	10 μ F, 35 V Tantalum Capacitor	T491D106K035AT	Kemet
C12	68 pF Chip Capacitor	ATC100B680JT500XT	ATC
C13	27 pF Chip Capacitor	ATC100B270JT500XT	ATC
C21	330 μ F, 63 V Electrolytic Capacitor	MCRH63V337M13X21-RH	Multicomp
L1	17.5 nH Inductor	B06T	CoilCraft
L2	43 nH Inductor	B10T	CoilCraft
L3, L4, L5, L6	82 nH Inductors	1812SMS-82NJ	CoilCraft
R1	180 Ω , 1/4 W Chip Resistor	CRCW1206180RFKEA	Vishay
PCB	0.030", $\epsilon_r = 2.55$	CuClad 250GX-0300-55-22	Arlon



$V_{DD} = 50 \text{ Vdc}$, $I_{DQ} = 30 \text{ mA}$, $P_{out} = 10 \text{ W CW}$

f MHz	Z_{source} Ω	Z_{load} Ω
64	$37.5 + j15.1$	$94.5 + j16.7$
130	$26.7 + j21.3$	$83.8 + j35.0$
220	$20.0 + j25.4$	$75.0 + j44.0$
450	$7.70 + j21.0$	$43.0 + j49.0$

Z_{source} = Test circuit impedance as measured from gate to ground.

Z_{load} = Test circuit impedance as measured from drain to ground.

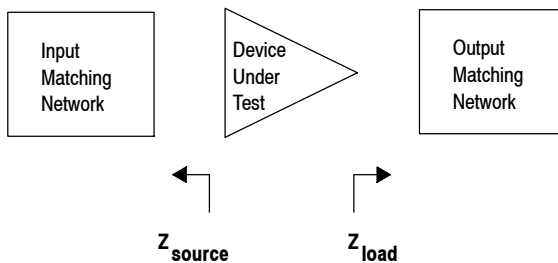

Figure 19. Series Equivalent Source and Load Impedance

50 OHM TYPICAL CHARACTERISTICS

Table 10. Common Source S-Parameters ($V_{DD} = 50\text{ V}$, $I_{DQ} = 30\text{ mA}$, $T_A = 25^\circ\text{C}$, 50 Ohm System)

f MHz	S ₁₁		S ₂₁		S ₁₂		S ₂₂	
	S ₁₁	∠ φ	S ₂₁	∠ φ	S ₁₂	∠ φ	S ₂₂	∠ φ
10	0.997	-5.0	11.520	175.6	0.000790	84.6	0.960	-0.8
20	0.994	-9.5	11.419	171.6	0.00157	84.3	0.962	-3.5
30	0.992	-14.5	11.356	167.9	0.00232	78.1	0.963	-5.5
40	0.987	-19.3	11.278	164.1	0.00307	74.6	0.964	-7.7
50	0.981	-24.0	11.187	160.1	0.00380	71.0	0.964	-9.9
60	0.974	-28.6	11.042	156.1	0.00449	67.4	0.963	-12.1
70	0.965	-33.0	10.848	152.1	0.00513	63.8	0.961	-14.2
80	0.955	-37.4	10.636	148.2	0.00574	60.4	0.958	-16.3
90	0.944	-41.6	10.405	144.5	0.00631	57.0	0.955	-18.4
100	0.933	-45.7	10.147	140.8	0.00683	53.8	0.951	-20.4
120	0.912	-53.3	9.603	134.2	0.00776	47.9	0.944	-24.2
140	0.892	-60.4	9.061	127.9	0.00851	42.4	0.936	-27.9
160	0.873	-66.7	8.516	122.2	0.00914	37.6	0.929	-31.3
180	0.856	-72.7	7.993	116.9	0.00967	32.9	0.923	-34.6
200	0.841	-78.1	7.497	112.1	0.0101	28.7	0.918	-37.9
220	0.828	-83.0	7.040	107.5	0.0104	24.9	0.914	-41.1
240	0.819	-87.5	6.612	103.3	0.0107	21.3	0.912	-44.2
260	0.810	-91.7	6.214	99.3	0.0109	18.0	0.909	-47.2
280	0.804	-95.5	5.845	95.7	0.0110	15.0	0.908	-50.2
300	0.799	-99.0	5.507	92.2	0.0112	11.9	0.907	-53.0
320	0.796	-102.2	5.192	88.8	0.0112	9.1	0.906	-55.9
340	0.794	-105.1	4.901	85.7	0.0113	6.5	0.906	-58.6
360	0.793	-107.8	4.630	82.8	0.0112	4.1	0.906	-61.4
380	0.793	-110.4	4.382	79.9	0.0112	2.0	0.906	-64.1
400	0.794	-112.7	4.152	77.2	0.0112	-0.3	0.906	-66.7
420	0.796	-114.9	3.937	74.6	0.0112	-2.5	0.907	-69.3
440	0.798	-116.9	3.733	72.2	0.0111	-4.4	0.907	-71.8
460	0.800	-118.8	3.547	69.8	0.0110	-6.5	0.908	-74.2
480	0.803	-120.5	3.372	67.6	0.0109	-8.5	0.908	-76.7
500	0.807	-122.2	3.213	65.4	0.0108	-10.0	0.909	-79.0
520	0.810	-123.8	3.061	63.3	0.0107	-11.9	0.910	-81.3
540	0.814	-125.4	2.919	61.2	0.0105	-13.5	0.911	-83.6
560	0.817	-126.8	2.784	59.3	0.0104	-14.9	0.912	-85.8
580	0.821	-128.1	2.661	57.5	0.0103	-16.6	0.914	-87.9
600	0.825	-129.3	2.545	55.7	0.0101	-18.1	0.915	-90.0
620	0.829	-130.5	2.436	53.9	0.00996	-19.6	0.917	-92.1
640	0.833	-131.6	2.334	52.2	0.00981	-21.0	0.918	-94.1
660	0.837	-132.7	2.237	50.5	0.00963	-22.4	0.920	-96.0
680	0.840	-133.8	2.144	48.9	0.00946	-23.7	0.921	-97.9
700	0.843	-134.8	2.058	47.3	0.00928	-25.0	0.923	-99.7
720	0.847	-135.8	1.977	45.8	0.00910	-26.1	0.924	-101.4
740	0.850	-136.8	1.900	44.4	0.00894	-27.3	0.926	-103.0
760	0.854	-137.8	1.828	43.0	0.00876	-28.6	0.928	-104.7
780	0.857	-138.7	1.760	41.6	0.00859	-29.7	0.930	-106.2

(continued)

50 OHM TYPICAL CHARACTERISTICS

Table 10. Common Source S-Parameters ($V_{DD} = 50\text{ V}$, $I_{DQ} = 30\text{ mA}$, $T_A = 25^\circ\text{C}$, 50 Ohm System) (continued)

f MHz	S ₁₁		S ₂₁		S ₁₂		S ₂₂	
	S ₁₁	∠ φ	S ₂₁	∠ φ	S ₁₂	∠ φ	S ₂₂	∠ φ
800	0.858	-139.7	1.697	40.2	0.00839	-31.1	0.932	-107.6
820	0.861	-140.7	1.636	38.9	0.00818	-32.1	0.934	-109.0
840	0.864	-141.6	1.578	37.6	0.00798	-33.1	0.935	-110.4
860	0.867	-142.6	1.523	36.4	0.00781	-33.8	0.936	-111.7
880	0.870	-143.5	1.471	35.1	0.00763	-34.8	0.938	-112.9
900	0.873	-144.5	1.421	33.9	0.00745	-35.9	0.939	-114.1

PACKAGE DIMENSIONS

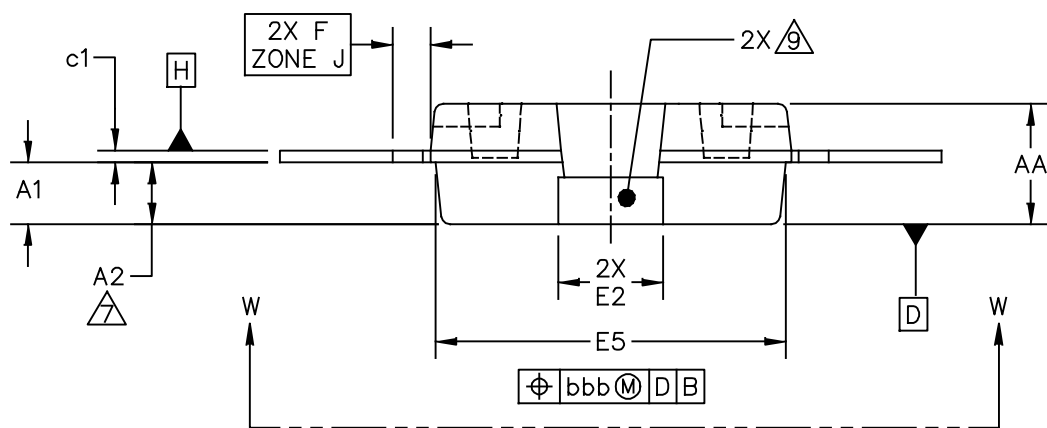
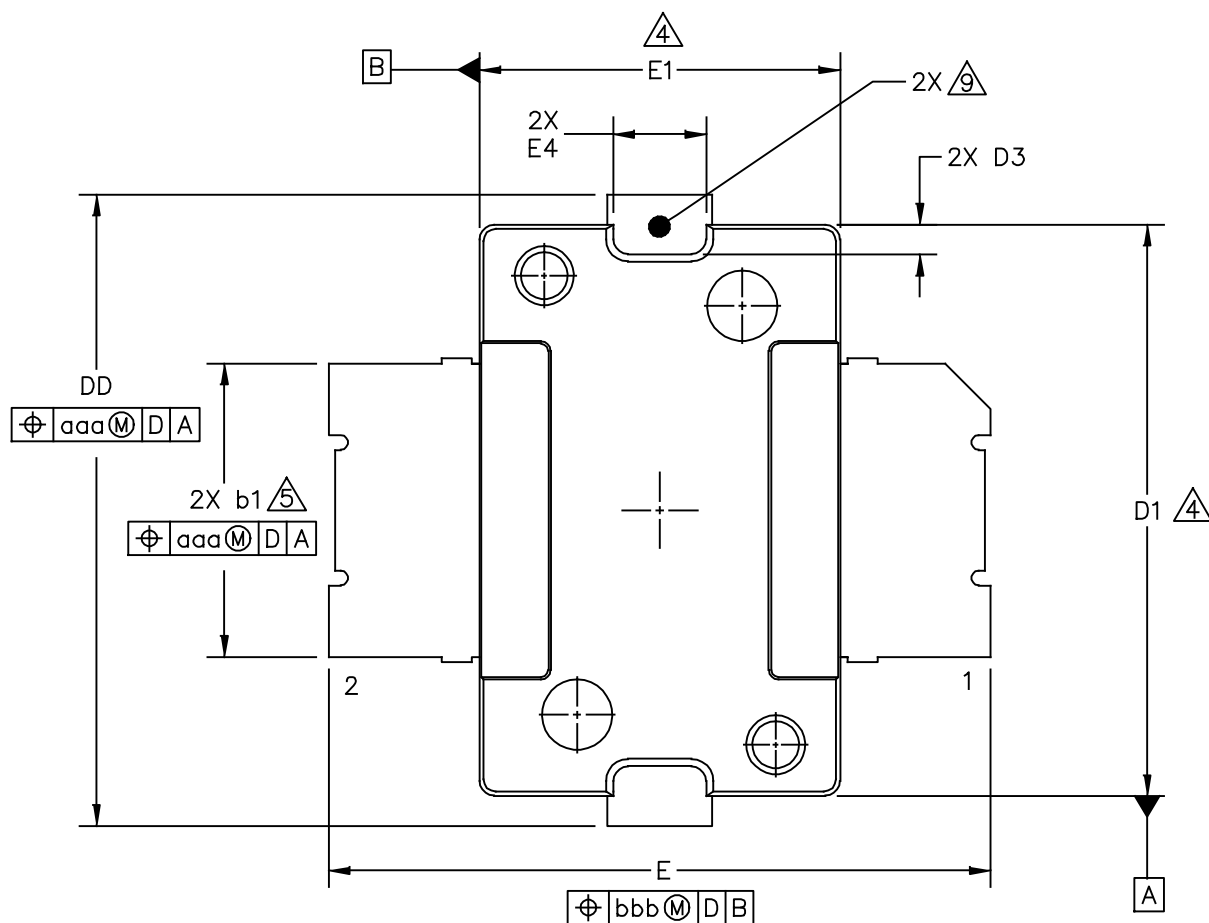

© FREESCALE SEMICONDUCTOR, INC. ALL RIGHTS RESERVED.	MECHANICAL OUTLINE	PRINT VERSION NOT TO SCALE
TITLE: TO-270-2	DOCUMENT NO: 98ASH98117A	REV: P
	STANDARD: NON-JEDEC	
	02 JUN 2014	

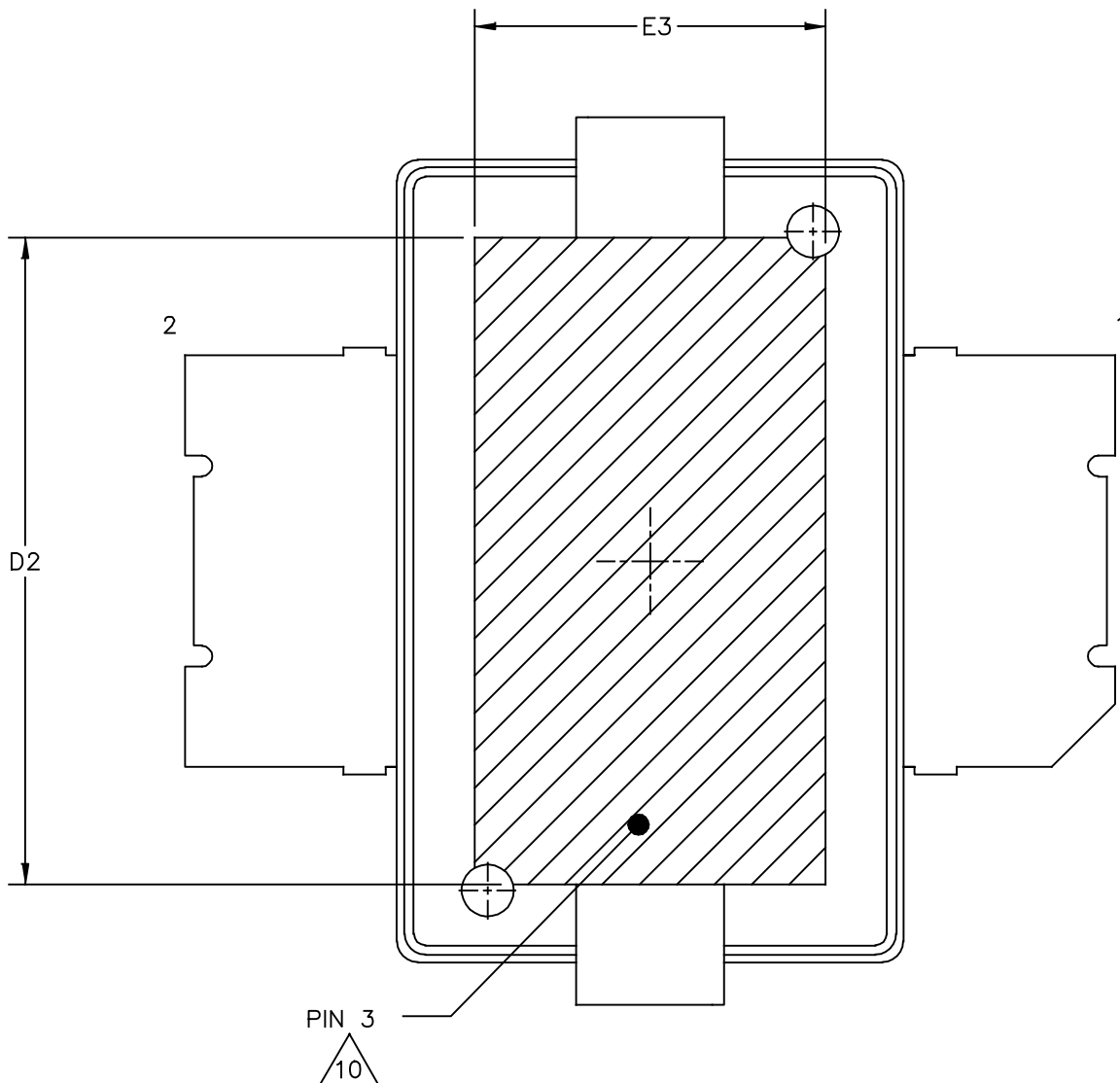

VIEW W-W
BOTTOM VIEW

© FREESCALE SEMICONDUCTOR, INC. ALL RIGHTS RESERVED.	MECHANICAL OUTLINE	PRINT VERSION NOT TO SCALE	
TITLE: TO-270-2		DOCUMENT NO: 98ASH98117A	REV: P
		STANDARD: NON-JEDEC	
		02 JUN 2014	

NOTES:

1. CONTROLLING DIMENSION: INCH
2. INTERPRET DIMENSIONS AND TOLERANCES PER ASME Y14.5M-1994.
3. DATUM PLANE H IS LOCATED AT TOP OF LEAD AND IS COINCIDENT WITH THE LEAD WHERE THE LEAD EXITS THE PLASTIC BODY AT THE TOP OF THE PARTING LINE.

4. DIMENSIONS D1 AND E1 DO NOT INCLUDE MOLD PROTRUSION. ALLOWABLE PROTRUSION IS .006 INCH (0.15 MM) PER SIDE. DIMENSIONS D1 AND E1 DO INCLUDE MOLD MISMATCH AND ARE DETERMINED AT DATUM PLANE H.

5. DIMENSION b1 DOES NOT INCLUDE DAMBAR PROTRUSION. ALLOWABLE DAMBAR PROTRUSION SHALL BE .005 INCH (0.13 MM) TOTAL IN EXCESS OF THE b1 DIMENSION AT MAXIMUM MATERIAL CONDITION.

6. DATUMS A AND B TO BE DETERMINED AT DATUM PLANE H.

7. DIMENSION A2 APPLIES WITHIN ZONE J ONLY.

8. DIMENSIONS DD AND E2 DO NOT INCLUDE MOLD PROTRUSION. OVERALL LENGTH INCLUDING MOLD PROTRUSION SHOULD NOT EXCEED 0.430 INCH (10.92 MM) FOR DIMENSION DD AND 0.080 INCH (2.03 MM) FOR DIMENSION E2. DIMENSIONS DD AND E2 DO INCLUDE MOLD MISMATCH AND ARE DETERMINED AT DATUM PLANE D.

9. THESE SURFACES OF THE HEAT SLUG ARE NOT PART OF THE SOLDERABLE SURFACES AND MAY REMAIN UNPLATED.

10. HATCHING REPRESENTS THE EXPOSED AREA OF THE HEAT SLUG. DIMENSIONS D2 AND E3 REPRESENT THE VALUES BETWEEN THE TWO OPPOSITE POINTS ALONG THE EDGES OF EXPOSED AREA OF THE HEAT SLUG.

DIM	INCH		MILLIMETER		DIM	INCH		MILLIMETER	
	MIN	MAX	MIN	MAX		MIN	MAX	MIN	MAX
AA	.078	.082	1.98	2.08	E4	.058	.066	1.47	1.68
A1	.039	.043	0.99	1.09	E5	.231	.235	5.87	5.97
A2	.040	.042	1.02	1.07	F	.025 BSC		0.64 BSC	
DD	.416	.424	10.57	10.77	b1	.193	.199	4.90	5.06
D1	.378	.382	9.60	9.70	c1	.007	.011	0.18	0.28
D2	.290	----	7.37	----	aaa	.004		0.10	
D3	.016	.024	0.41	0.61	bbb	.008		0.20	
E	.436	.444	11.07	11.28					
E1	.238	.242	6.04	6.15					
E2	.066	.074	1.68	1.88					
E3	.150	----	3.81	----					

© FREESCALE SEMICONDUCTOR, INC. ALL RIGHTS RESERVED.		MECHANICAL OUTLINE		PRINT VERSION NOT TO SCALE			
TITLE: TO-270-2			DOCUMENT NO: 98ASH98117A		REV: P		
			STANDARD: NON-JEDEC				
						02 JUN 2014	

PRODUCT DOCUMENTATION AND SOFTWARE

Refer to the following resources to aid your design process.

Application Notes

- AN1907: Solder Reflow Attach Method for High Power RF Devices in Plastic Packages
- AN1955: Thermal Measurement Methodology of RF Power Amplifiers

Engineering Bulletins

- EB212: Using Data Sheet Impedances for RF LDMOS Devices

Software

- Electromigration MTTF Calculator

For Software, do a Part Number search at <http://www.freescale.com>, and select the "Part Number" link. Go to the Software & Tools tab on the part's Product Summary page to download the respective tool.

REVISION HISTORY

The following table summarizes revisions to this document.

Revision	Date	Description
0	July 2014	<ul style="list-style-type: none"> • Initial Release of Data Sheet

How to Reach Us:

Home Page:
freescale.com

Web Support:
freescale.com/support

Information in this document is provided solely to enable system and software implementers to use Freescale products. There are no express or implied copyright licenses granted hereunder to design or fabricate any integrated circuits based on the information in this document.

Freescale reserves the right to make changes without further notice to any products herein. Freescale makes no warranty, representation, or guarantee regarding the suitability of its products for any particular purpose, nor does Freescale assume any liability arising out of the application or use of any product or circuit, and specifically disclaims any and all liability, including without limitation consequential or incidental damages. "Typical" parameters that may be provided in Freescale data sheets and/or specifications can and do vary in different applications, and actual performance may vary over time. All operating parameters, including "typicals," must be validated for each customer application by customer's technical experts. Freescale does not convey any license under its patent rights nor the rights of others. Freescale sells products pursuant to standard terms and conditions of sale, which can be found at the following address: freescale.com/SalesTermsandConditions.

Freescale and the Freescale logo are trademarks of Freescale Semiconductor, Inc., Reg. U.S. Pat. & Tm. Off. All other product or service names are the property of their respective owners.

© 2014 Freescale Semiconductor, Inc.