

## Low Power, 14V, 200mA LDO Regulator

### General Description

The RT9077 is a low-dropout (LDO) voltage regulator with enable function offering benefits of up to 14V input voltage, low-dropout, low-power operation, and miniaturized packaging.

The features of low quiescent current and almost zero disable current is ideal for powering the battery equipment to a longer service life. The RT9077 is stable with ceramic output capacitors over its wide input range from 3.5V to 14V and entire range of output load current (0mA to 200mA).

### Applications

- Portable, Battery Powered Equipments
- Ultra Low Voltage Microcontrollers
- Notebook Computers

### Pin Configurations

(TOP VIEW)

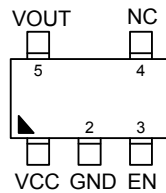

TSOT-23-5

### Marking Information

For marking information, contact our sales representative directly or through a Richtek distributor located in your area.

### Features

- **Maximum Operating Input Voltage 14V**
- **±2% Output Accuracy**
- **200mA Output Current with EN**
- **Less than 0.1µA Zero Disable Current**
- **Dropout Voltage : 0.4V at 100mA**
- **Support Fixed Output Voltage 2.5V, 3.3V, 4.2V, 5V, 8V, 9V**
- **Stable with Ceramic or Tantalum Capacitor**
- **Current Limit Protection**
- **Over-Temperature Protection**
- **RoHS Compliant and Halogen Free**

### Ordering Information

RT9077-□□□□

- Package Type  
J5 : TSOT-23-5
- Lead Plating System  
G : Green (Halogen Free and Pb Free)
- Output Voltage  
25 : 2.5V  
33 : 3.3V  
42 : 4.2V  
50 : 5V  
80 : 8V  
90 : 9V

Note :

Richtek products are :

- ▶ RoHS compliant and compatible with the current requirements of IPC/JEDEC J-STD-020.
- ▶ Suitable for use in SnPb or Pb-free soldering processes.

### Simplified Application Circuit

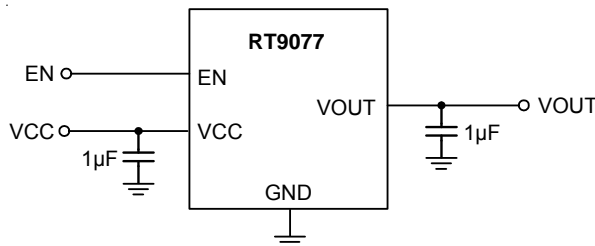

## Pin Description

Pin No.	Pin Name	Pin Function
1	VCC	Supply Voltage Input.
2	GND	Ground.
3	EN	Enable Control Input.
4	NC	No Internal Connection.
5	VOUT	Output of the Regulator.

## Function Block Diagram

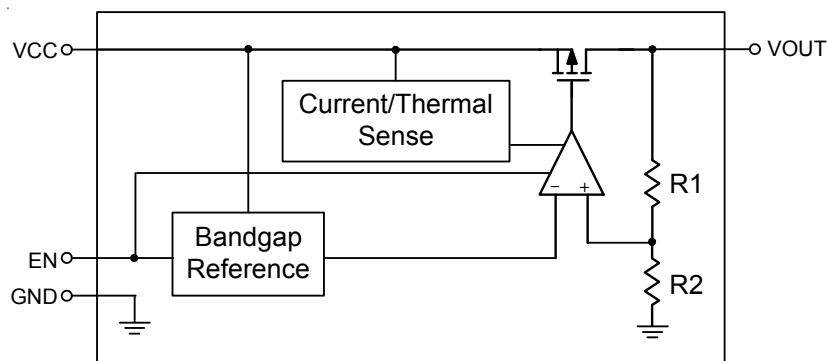

## Operation

### Basic Operation

The RT9077 is a low quiescent current linear regulator designed especially for low external component systems. The input voltage range is from 3.5V to 14V.

### Output Transistor

The RT9077 builds in a P-MOSFET output transistor which provides a low switch-on resistance for low dropout voltage applications.

### Error Amplifier

The Error Amplifier compares the internal reference voltage with the output feedback voltage from the internal divider, and controls the Gate voltage of P-MOSFET to support good line regulation and load regulation at output voltage.

### Enable

The RT9077 delivers the output power when it is set to enable state. When it works in disable state, there is almost no output power and the operation quiescent current is less than 0.1 $\mu$ A (typ.).

### Current Limit Protection

The RT9077 provides current limit function to prevent the device from damages during over-load or shorted-circuit conditions. This current is detected by an internal sensing transistor.

### Over-Temperature Protection

The over-temperature protection function turns off the P-MOSFET when the junction temperature exceeds 150 $^{\circ}$ C (typ.) and the output current exceeds 30mA. Once the junction temperature cools down by approximately 150 $^{\circ}$ C, the regulator automatically resumes operation.

**Absolute Maximum Ratings** (Note 1)

- VCC, EN to GND ----- -0.3V to 15V
- VOUT to GND  
 RT9077-90 ----- -0.3V to 15V  
 RT9077-25/ RT9077-33/ RT9077-50 ----- -0.3V to 6V
- VOUT to VCC ----- -15V to 0.3V
- Power Dissipation, P<sub>D</sub> @ T<sub>A</sub> = 25°C  
 TSOT-23-5 ----- 0.43W
- Package Thermal Resistance (Note 2)  
 TSOT-23-5, θ<sub>JA</sub> ----- 230.6°C/W
- Junction Temperature ----- 150°C
- Lead Temperature (Soldering, 10 sec.) ----- 260°C
- Storage Temperature Range ----- -60°C to 150°C
- ESD Susceptibility (Note 3)  
 HBM (Human Body Model) ----- 2kV

**Recommended Operating Conditions** (Note 4)

- Supply Input Voltage ----- 3.5V to 14V
- Junction Temperature Range ----- -40°C to 125°C
- Ambient Temperature Range ----- -40°C to 85°C

**Electrical Characteristics**

(V<sub>OUT</sub> + 1 < V<sub>CC</sub> < 14V, T<sub>A</sub> = 25°C, unless otherwise specified)

Parameter	Symbol	Test Conditions	Min	Typ	Max	Unit
Supply Voltage	V <sub>CC</sub>		3.5	--	14	V
Output Voltage Range	V <sub>OUT</sub>		2.5	--	12	V
DC Output Accuracy	ΔV <sub>OUT</sub>	I <sub>LOAD</sub> = 1mA	-2	--	2	%
Dropout Voltage	V <sub>DROP</sub>	I <sub>LOAD</sub> = 100mA, V <sub>CC</sub> > 4.5V	--	0.4	1.2	V
		I <sub>LOAD</sub> = 100mA, V <sub>CC</sub> > 3.5V and < 4.5V	--	--	1.5	V
VCC Consumption Current	I <sub>Q</sub>	I <sub>LOAD</sub> = 20mA	--	70	100	μA
Shutdown GND Current		V <sub>EN</sub> = 0V	--	0.1	1	μA
Shutdown Leakage Current		V <sub>EN</sub> = 0V, V <sub>OUT</sub> = 0V	--	0.1	1	μA
EN Input Current	I <sub>EN</sub>	V <sub>EN</sub> = 14V	--	0.1	--	μA
Line Regulation	ΔV <sub>LINE</sub>	I <sub>LOAD</sub> = 1mA, 5.5V < V <sub>CC</sub> < 14V	--	--	0.4	%
		I <sub>LOAD</sub> = 1mA, 3.5V < V <sub>CC</sub> < 5.5V	--	0.1	0.2	%
Load Regulation	ΔV <sub>LOAD</sub>	1mA < I <sub>LOAD</sub> < 200mA	--	0.5	1	%
Output Current Limit	I <sub>LIM</sub>	V <sub>OUT</sub> = 0.5 x V <sub>OUT(normal)</sub>	210	350	490	mA
Enable Input Voltage	Logic-High	V <sub>IH</sub>	--	--	2	V
	Logic-Low	V <sub>IL</sub>	0.6	--	--	
Thermal Shutdown Temperature	T <sub>SD</sub>	I <sub>LOAD</sub> = 30mA	--	150	--	°C
Thermal Shutdown Hysteresis	ΔT <sub>SD</sub>		--	20	--	°C

**Note 1.** Stresses beyond those listed “Absolute Maximum Ratings” may cause permanent damage to the device. These are stress ratings only, and functional operation of the device at these or any other conditions beyond those indicated in the operational sections of the specifications is not implied. Exposure to absolute maximum rating conditions may affect device reliability.

**Note 2.**  $\theta_{JA}$  is measured at  $T_A = 25^\circ\text{C}$  on a high effective thermal conductivity four-layer test board per JEDEC 51-7.

**Note 3.** Devices are ESD sensitive. Handling precaution is recommended.

**Note 4.** The device is not guaranteed to function outside its operating conditions.

## Typical Application Circuit

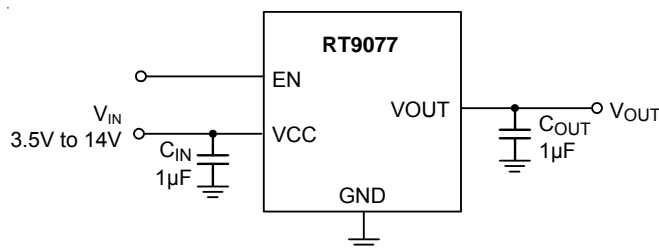

Typical Operating Characteristics

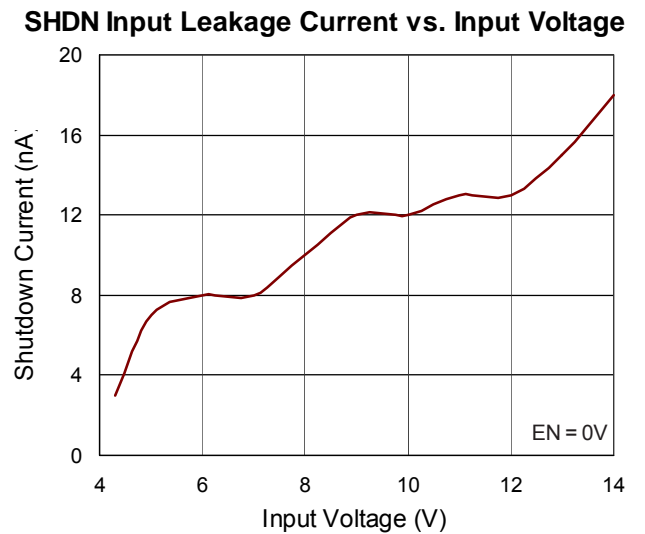
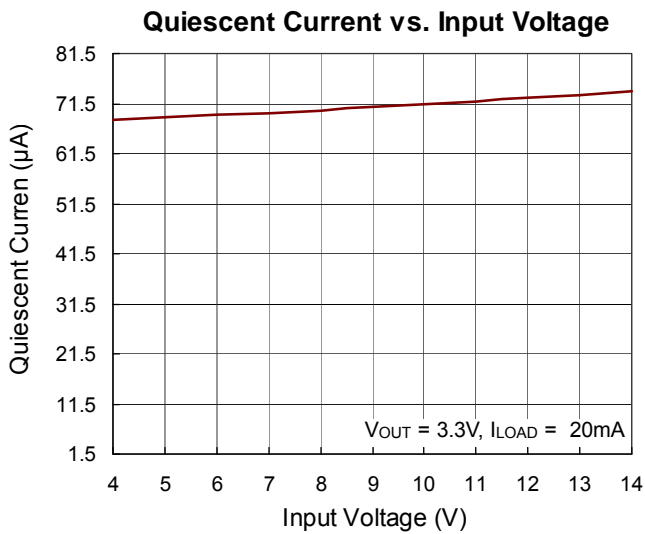
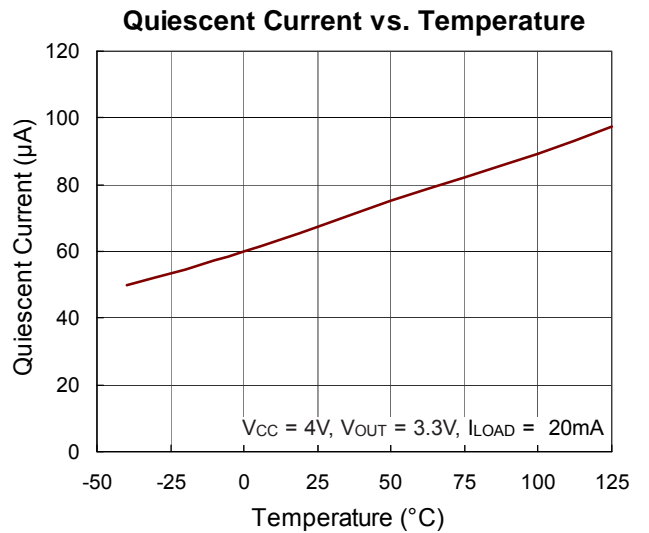
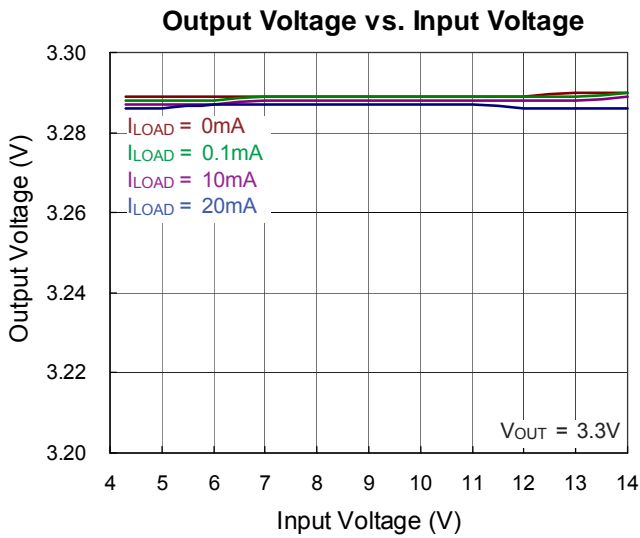
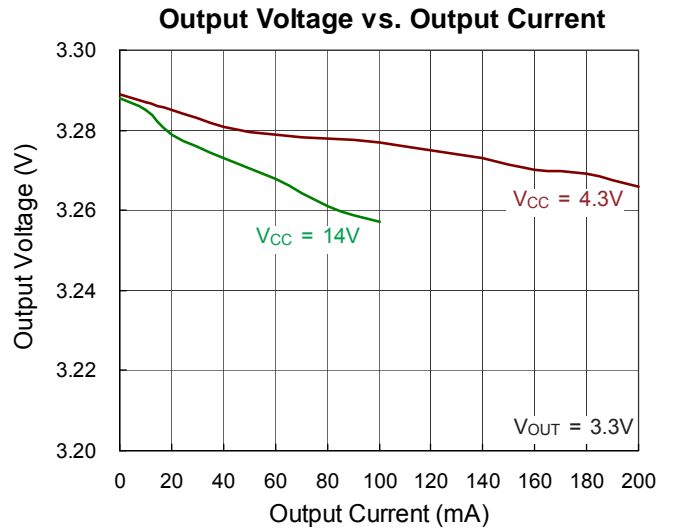
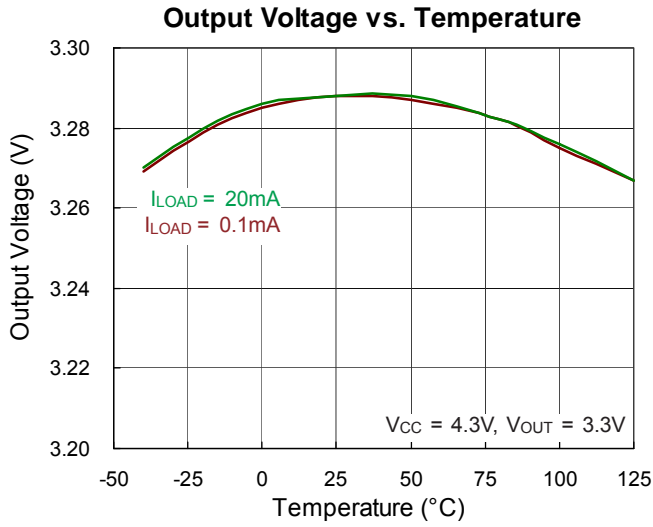

SHDN Input Leakage Current vs. Temperature

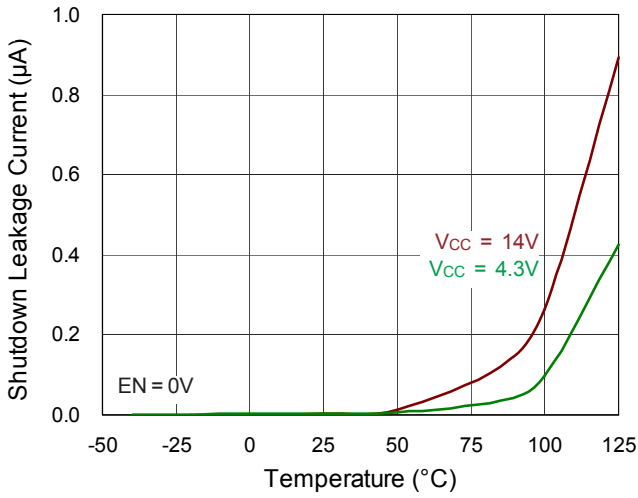

EN Voltage vs. Input Voltage

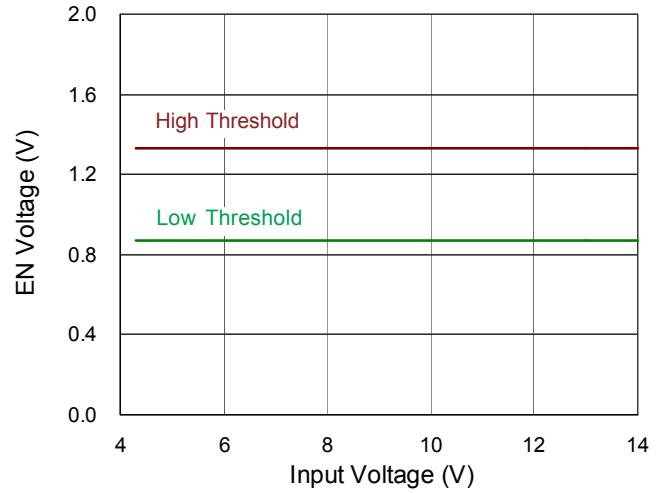

EN Voltage vs. Temperature

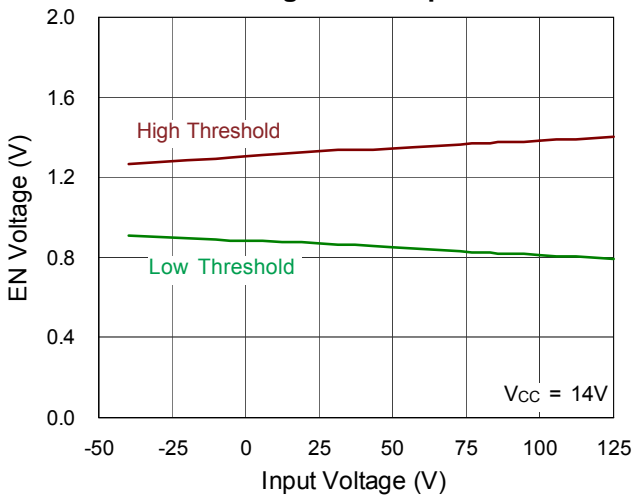

Dropout Voltage vs. Temperature

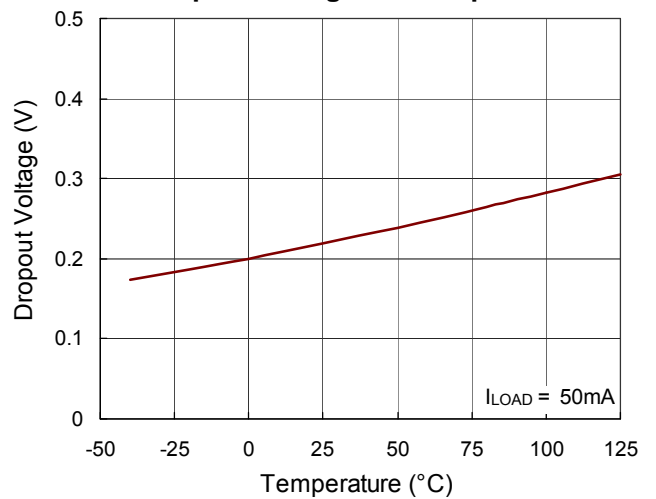

Current Limit vs. Temperature

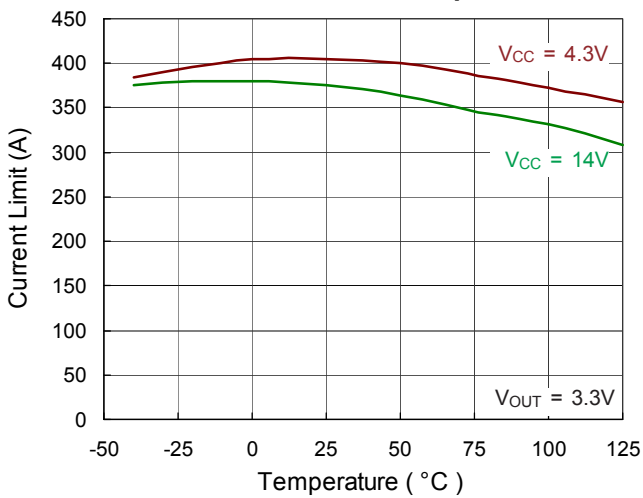

PSRR vs. Frequency

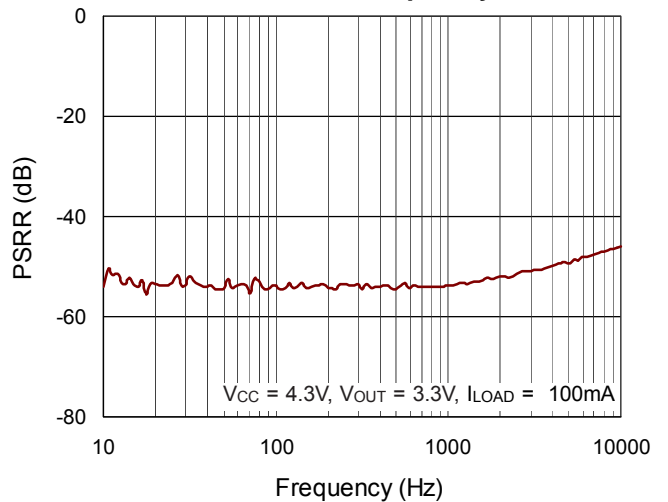

**Load Transient Response**

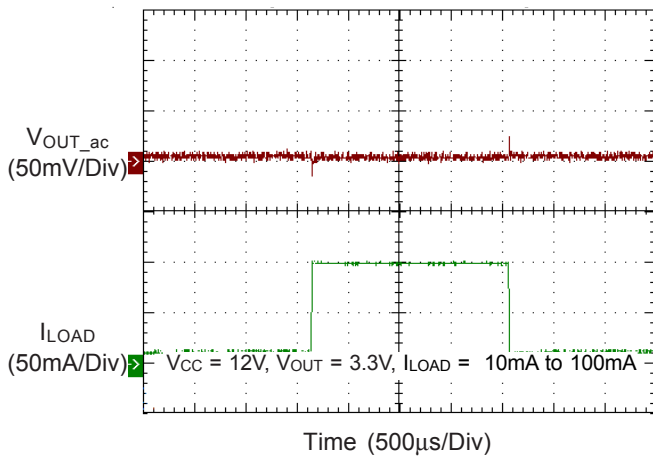

**Load Transient Response**

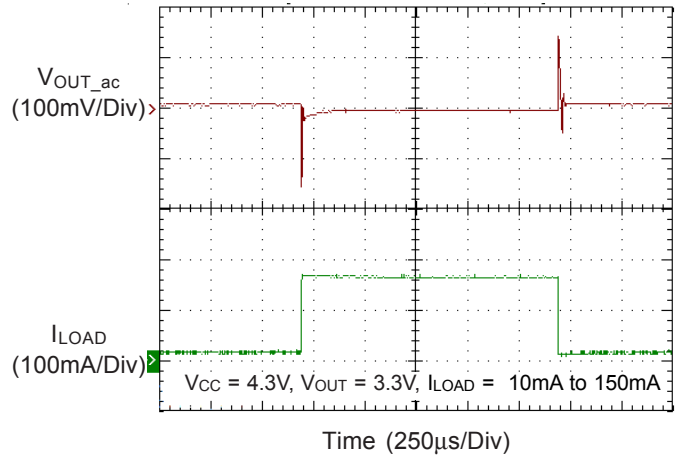

**Line Transient Response**

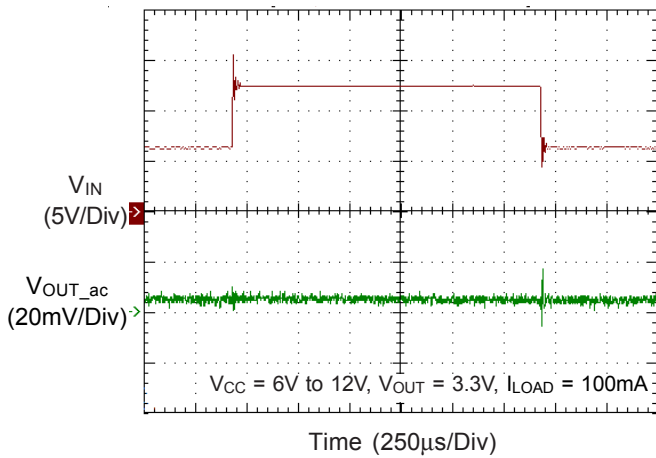

**Power On from EN**

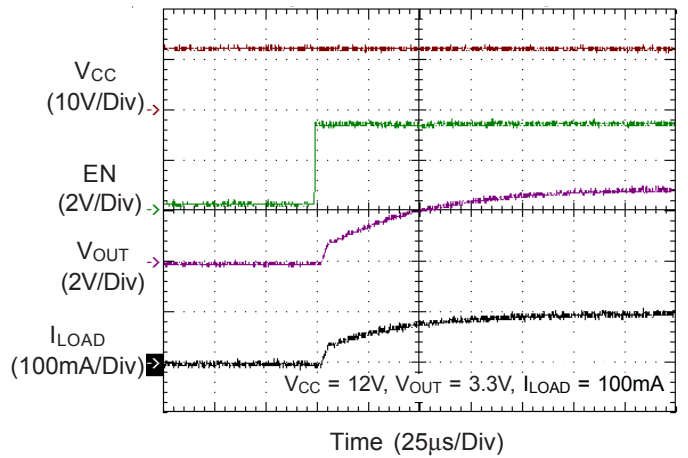

**Power Off from EN**

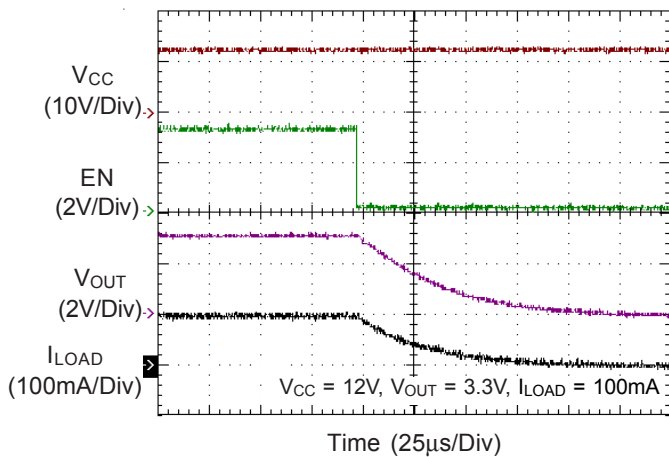

## Applications Information

Like any low dropout linear regulator, the RT9077's external input and output capacitors must be properly selected for stability and performance. Use a 1μF or larger input capacitor and place it close to the IC's VCC and GND pins. Any output capacitor meets the minimum 1mΩ ESR (Equivalent Series Resistance) requirement may be used. Place the output capacitor close to the IC's VOUT and GND pins. Increasing capacitance and decreasing ESR can improve the circuit's PSRR and line transient response.

### Enable

The RT9077 goes into shutdown mode when the EN pin is in a logic low condition. During this condition, the RT9077 has an EN pin to turn on or turn off the regulator. When the EN pin is in logic high, the regulator will be turned on. The shutdown current is almost 0μA typical. The EN pin may be directly tied to VCC to keep the part on. The Enable input is CMOS logic and cannot be left floating.

### Current Limit

The RT9077 contains an independent current limiter, which monitors and controls the pass transistor's gate voltage, limiting the output current to 0.35A (typ.). The output can be shorted to ground indefinitely without damaging the part.

### Thermal Considerations

For continuous operation, do not exceed absolute maximum junction temperature. The maximum power dissipation depends on the thermal resistance of the IC package, PCB layout, rate of surrounding airflow, and difference between junction and ambient temperature. The maximum power dissipation can be calculated by the following formula :

$$P_{D(MAX)} = (T_{J(MAX)} - T_A) / \theta_{JA}$$

where  $T_{J(MAX)}$  is the maximum junction temperature,  $T_A$  is the ambient temperature, and  $\theta_{JA}$  is the junction to ambient thermal resistance.

For recommended operating condition specifications, the maximum junction temperature is 125°C. The junction to ambient thermal resistance,  $\theta_{JA}$ , is layout dependent. For TSOT-23-5 package, the thermal resistance,  $\theta_{JA}$ , is 230.6°C/W on a standard JEDEC 51-7 four-layer thermal test board. The maximum power dissipation at  $T_A = 25^\circ\text{C}$  can be calculated by the following formula :

$$P_{D(MAX)} = (125^\circ\text{C} - 25^\circ\text{C}) / (230.6^\circ\text{C/W}) = 0.43\text{W for TSOT-23-5 package}$$

The maximum power dissipation depends on the operating ambient temperature for fixed  $T_{J(MAX)}$  and thermal resistance,  $\theta_{JA}$ . The derating curve in Figure 1 allows the designer to see the effect of rising ambient temperature on the maximum power dissipation.

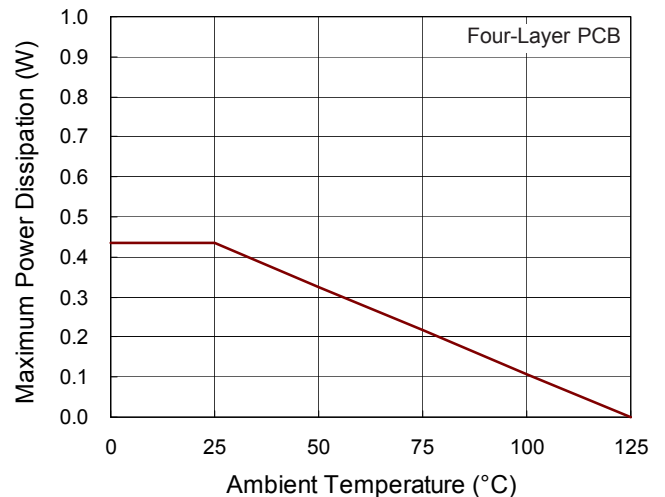
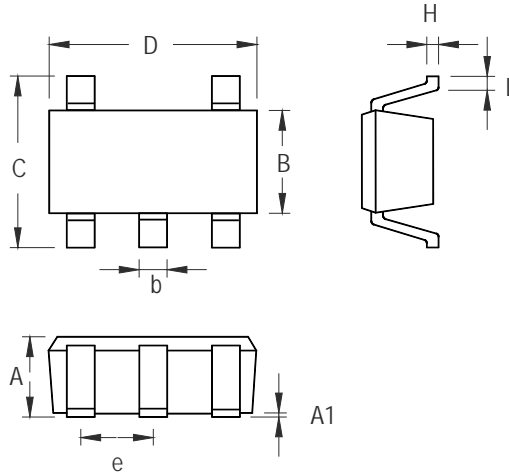

Figure 1. Derating Curve of Maximum Power Dissipation



**Outline Dimension**



Symbol	Dimensions In Millimeters		Dimensions In Inches	
	Min	Max	Min	Max
A	0.700	1.000	0.028	0.039
A1	0.000	0.100	0.000	0.004
B	1.397	1.803	0.055	0.071
b	0.300	0.559	0.012	0.022
C	2.591	3.000	0.102	0.118
D	2.692	3.099	0.106	0.122
e	0.838	1.041	0.033	0.041
H	0.080	0.254	0.003	0.010
L	0.300	0.610	0.012	0.024

**TSOT-23-5 Surface Mount Package**

**Richtek Technology Corporation**

14F, No. 8, Tai Yuen 1<sup>st</sup> Street, Chupei City  
 Hsinchu, Taiwan, R.O.C.  
 Tel: (8863)5526789

Richtek products are sold by description only. Richtek reserves the right to change the circuitry and/or specifications without notice at any time. Customers should obtain the latest relevant information and data sheets before placing orders and should verify that such information is current and complete. Richtek cannot assume responsibility for use of any circuitry other than circuitry entirely embodied in a Richtek product. Information furnished by Richtek is believed to be accurate and reliable. However, no responsibility is assumed by Richtek or its subsidiaries for its use; nor for any infringements of patents or other rights of third parties which may result from its use. No license is granted by implication or otherwise under any patent or patent rights of Richtek or its subsidiaries.