

# IFX4949

5V Low Drop Out Linear Voltage Regulator

IFX4949SJ

## Data Sheet

Rev. 1.0, 2012-05-07

StandardPower

## Table of Contents

<b>1</b>	<b>Overview</b> .....	<b>3</b>
<b>2</b>	<b>Block Diagram</b> .....	<b>4</b>
<b>3</b>	<b>Pin Configuration</b> .....	<b>5</b>
3.1	Pin Assignment PG-DSO-8 .....	5
3.2	Pin Definitions and Functions PG-DSO-8 .....	5
<b>4</b>	<b>General Product Characteristics</b> .....	<b>6</b>
4.1	Absolute Maximum Ratings .....	6
4.2	Functional Range .....	7
4.3	Thermal Resistance .....	7
4.4	Electrical Characteristics .....	8
4.4.1	Voltage Regulator .....	8
4.4.2	RESET .....	9
4.4.3	Sense .....	9
4.4.4	Preregulator .....	10
4.5	Typical Performance Graphs .....	11
<b>5</b>	<b>Application Information</b> .....	<b>14</b>
5.1	Supply Voltage Transients .....	14
5.2	Functional Description .....	14
<b>6</b>	<b>Package Outlines</b> .....	<b>19</b>
<b>7</b>	<b>Revision History</b> .....	<b>20</b>



## 1 Overview

### Features

- Operating DC Supply Voltage Range 5 V to 28 V
- Transient Supply Voltage up to 40 V
- Extremely low Quiescent Current in Standby Mode
- High Precision Standby Output Voltage 5 V  $\pm$ 1%
- Output Current Capability up to 100 mA
- Very low Dropout Voltage less than 0.5 V
- Reset Circuit sensing the Output Voltage
- Programmable Reset Pulse Delay with External Capacitor
- Voltage Sense Comparator
- Thermal Shutdown and Short Circuit Protections
- Green Product (RoHS)

### Description

The IFX4949 is a monolithic integrated 5V voltage regulator with a very low dropout output and additional functions as undervoltage reset with power-on reset delay and input voltage sense. It is designed to supply microcontroller controlled systems in all kinds of applications.

The IFX4949 is not to be used in automotive applications. For automotive applications please refer to the Infineon TLF4949 voltage regulator series.

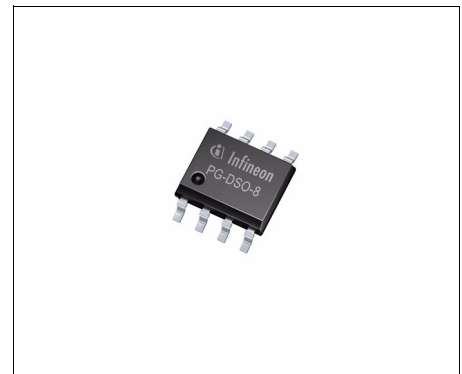

PG-DSO-8

Type	Package	Marking
IFX4949SJ	PG-DSO-8	IFX4949S

## 2 Block Diagram

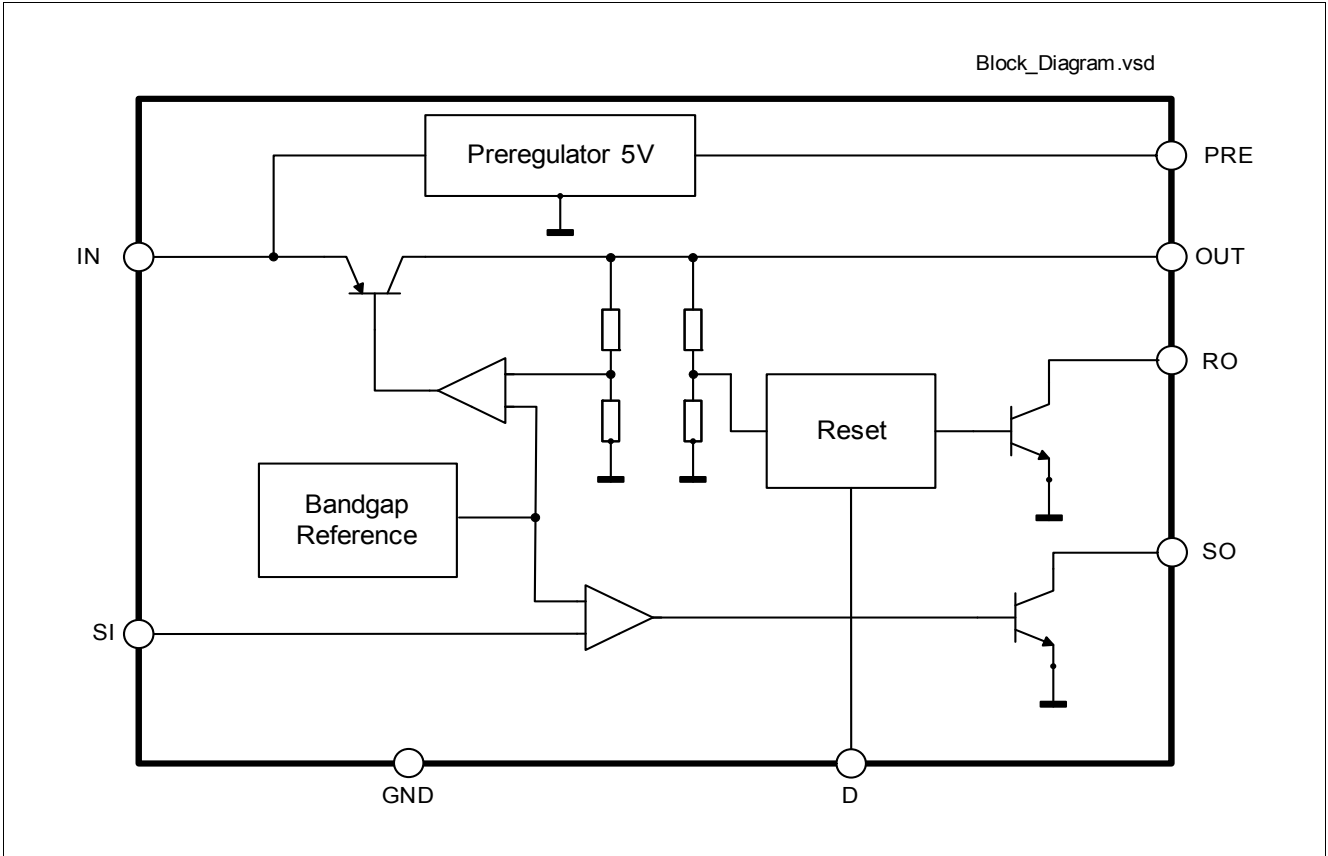

Figure 1 Block Diagram

### 3 Pin Configuration

#### 3.1 Pin Assignment PG-DSO-8

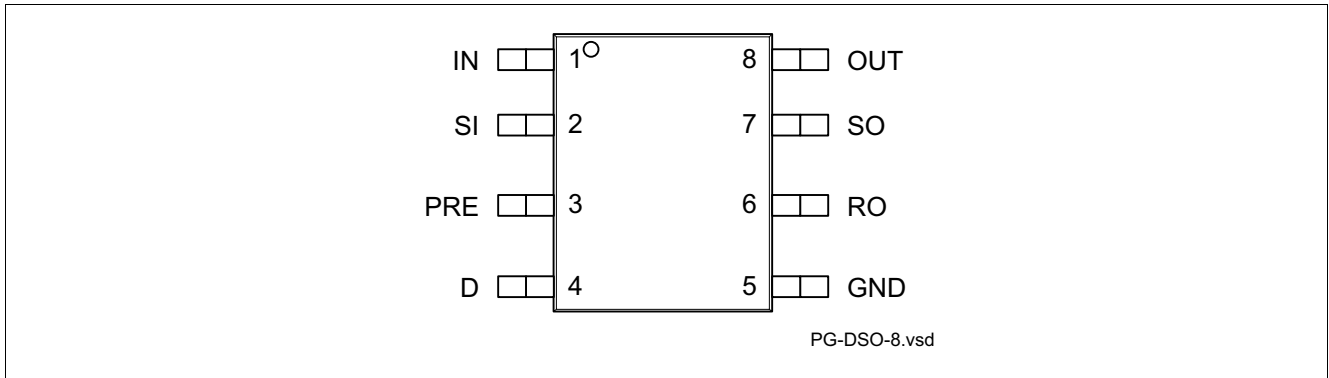

Figure 2 Pin Configuration PG-DSO-8

#### 3.2 Pin Definitions and Functions PG-DSO-8

Pin	Symbol	Function
1	IN	<b>Input</b> ; block to GND directly at the IC with a ceramic capacitor.
2	SI	<b>Sense Input</b> ; if not needed connect to OUT
3	PRE	<b>Preregulator Output</b> ;
4	D	<b>Reset Delay</b> ; to select delay time, connect to GND via capacitor.
5	GND	<b>Ground</b>
6	RO	<b>Reset Output</b> ; open-collector output. Keep open, if not needed.
7	SO	<b>Sense Output</b> ; open-collector output. Keep open, if not needed.
8	OUT	<b>5-V Output</b> ; connect to GND with a capacitor $\geq 4.7\mu\text{F}$ , $\text{ESR} < 10 \Omega$ . <sup>1) 2)</sup>

1) For the usage of capacitors with very low ESR-values it is recommended to use a small  $1\Omega$  resistor in series.

2) Measured at  $f = 10\text{kHz}$ .

## 4 General Product Characteristics

### 4.1 Absolute Maximum Ratings

#### Absolute Maximum Ratings <sup>1)</sup>

$T_j = -40\text{ °C}$  to  $+125\text{ °C}$ ; all voltages with respect to ground, direction of current as shown in [Figure 3 “Application Diagram” on Page 14](#) (unless otherwise specified)

Pos.	Parameter	Symbol	Limit Values		Unit	Conditions
			Min.	Max.		
<b>Voltage Rating</b>						
4.1.1	DC Operating Supply	$V_{IN}$	-0.3	28	V	–
4.1.2	Transient Supply Voltage	$V_{IN\_TR}$	–	45	V	<sup>2)</sup>
4.1.3	Preregulator Output	$V_{PRE}$	–	7	V	–
4.1.4	Voltage Regulator Output	$V_{OUT}$	-0.3	20	V	–
4.1.5	Reset Output	$V_{RO}$	-0.3	20	V	–
4.1.6	Sense Input	$V_{SI}$	-30	40	V	–
4.1.7	Sense Output Voltage	$V_{SO}$	-0.3	20	V	–
4.1.8	Reset Delay	$V_D$	-0.3	7	V	–
<b>Current Rating</b>						
4.1.9	Preregulator Output	$I_{PRE}$	–	5	mA	–
4.1.10	Reset Out	$I_{RO}$	–	5	mA	–
4.1.11	Sense Out	$I_{SO}$	–	5	mA	–
<b>Temperatures</b>						
4.1.12	Junction Temperature	$T_j$	-40	150	°C	–
4.1.13	Storage Temperature	$T_{stg}$	-50	150	°C	–
<b>ESD Susceptibility</b>						
4.1.14	ESD Resistivity to GND	$V_{ESD}$	-4	4	kV	HBM <sup>3)</sup>
4.1.15	ESD Resistivity to GND	$V_{ESD}$	-1	1	kV	CDM <sup>4)</sup>

1) Not subject to production test, specified by design.

2) For transient durations of  $t_{TR} < 1\text{ s}$ .

3) ESD susceptibility, HBM according to ANSI/ESDA/JEDEC JS-001 (1.5 kΩ, 100 pF).

4) ESD susceptibility, Charged Device Model “CDM” ESDA STM5.3.1 or ANSI/ESD S.5.3.1.

*Note: Stresses above the ones listed here may cause permanent damage to the device. Exposure to absolute maximum rating conditions for extended periods may affect device reliability.*

*Note: Integrated protection functions are designed to prevent IC destruction under fault conditions described in the data sheet. Fault conditions are considered as “outside” normal operating range. Protection functions are not designed for continuous repetitive operation.*

## 4.2 Functional Range

**Table 1**

Pos.	Parameter	Symbol	Limit Values		Unit	Conditions
			Min.	Max.		
4.2.1	Input Voltage Range for Normal Operation	$V_{IN}$	5.5	28	V	–
4.2.2	Extended Input Voltage Range	$V_{IN}$	3.5	40	V	– <sup>1)</sup> 2)

1) The output voltage will follow the input voltage for input voltages below  $V_{OUT} + V_{DR}$ , i.e. device is in tracking mode until  $V_{OUT} + V_{DR}$  is reached.

2) Input voltages ranging from > 28 V up to 40 V may only be applied for transient periods  $t_{TR} < 1s$ .

*Note: Within the functional or operating range, the IC operates as described in the circuit description. The electrical characteristics are specified within the conditions given in the Electrical Characteristics table.*

## 4.3 Thermal Resistance

*Note: This thermal data was generated in accordance with JEDEC JESD51 standards. For more information, go to [www.jedec.org](http://www.jedec.org).*

Pos.	Parameter	Symbol	Limit Values			Unit	Conditions
			Min.	Typ.	Max.		
<b>IFX4949SJ (PG-DSO-8)</b>							
4.3.3	Junction to Soldering Point <sup>1)</sup>	$R_{thJSP}$	–	71	–	K/W	–
4.3.4	Junction to Ambient <sup>1)</sup>	$R_{thJA}$	–	116	–	K/W	– <sup>2)</sup>
4.3.5			–	172	–	K/W	Footprint only <sup>3)</sup>
4.3.6			–	145	–	K/W	300 mm <sup>2</sup> heatsink area on PCB <sup>3)</sup>
4.3.7			–	139	–	K/W	600 mm <sup>2</sup> heatsink area on PCB <sup>3)</sup>

### Thermal Shutdown

4.3.8	Junction Temperature	$T_{JSD}$	–	165	–	°C	1)
-------	----------------------	-----------	---	-----	---	----	----

1) Not subject to production test, specified by design.

2) Specified  $R_{thJA}$  value is according to Jedec JESD51-2,-7 at natural convection on FR4 2s2p board; The Product (Chip+Package) was simulated on a 76.2 x 114.3 x 1.5 mm board with 2 inner copper layers (2 x 70µm Cu, 2 x 35µm Cu).

3) Specified  $R_{thJA}$  value is according to JEDEC JESD 51-3 at natural convection on FR4 1s0p board; The Product (Chip+Package) was simulated on a 76.2 x 114.3 x 1.5 mm<sup>3</sup> board with 1 copper layer (1 x 70µm Cu).

## 4.4 Electrical Characteristics

### 4.4.1 Voltage Regulator

#### Electrical Characteristics: Regulator

$V_{IN} = 14\text{ V}$ ,  $T_j = -40\text{ °C}$  to  $+125\text{ °C}$ , all voltages with respect to ground, direction of current as shown in **Figure 3** “Application Diagram” on Page 14 (unless otherwise specified)

Pos.	Parameter	Symbol	Limit Values			Unit	Conditions
			Min.	Typ.	Max.		
4.4.1	Output Voltage	$V_{OUT}$	4.95	5	5.05	V	$T_J = 25\text{ °C}$ ; $I_{OUT} = 1\text{ mA}$
4.4.2			4.90	5	5.10	V	$6\text{ V} \leq V_{IN} \leq 28\text{ V}$ ; $1\text{ mA} \leq I_{OUT} \leq 50\text{ mA}$
4.4.3			4.85	–	5.15	V	$V_{IN} = 40\text{ V}^{1)}$ ; $5\text{ mA} \leq I_{OUT} \leq 100\text{ mA}$
4.4.4			4.85	5	5.15		$6\text{ V} \leq V_{IN} \leq 28\text{ V}$ ; $0\text{ mA} \leq I_{OUT} \leq 100\text{ mA}$
4.4.5	Dropout Voltage $V_{DR} = V_{IN} - V_{OUT}$	$V_{DR}$		0.1 0.2 0.3	0.25 0.4 0.5	V V V	$I_{OUT} = 10\text{ mA}$ $I_{OUT} = 50\text{ mA}$ $I_{OUT} = 100\text{ mA}$
4.4.6	Input to Output Voltage Difference in Undervoltage Condition	$V_{IO}$	–	0.17	0.4	V	$V_{IN} = 3.5\text{ V}$ ; $I_{OUT} = 35\text{ mA}$
4.4.7	Current Sink Capability from Output to GND	$I_{outh}^{2)}$	-30	-55	–	$\mu\text{A}$	$V_{IN} = 25\text{ V}$ ; $V_{OUT} = 5.5\text{ V}$
4.4.8	Line Regulation	$\Delta V_{OUT,line}$	–	1	15	mV	$6\text{ V} < V_{IN} < 28\text{ V}$ ; $I_{OUT} = 1\text{ mA}$
4.4.9	Load Regulation	$\Delta V_{OUT,load}$	–	4	20	mV	$1\text{ mA} \leq I_{OUT} \leq 100\text{ mA}$
4.4.10	Current Limit	$I_{OUT,lim}$	120	240 180	400	mA mA	$V_{OUT} = 4.5\text{ V}$ $V_{OUT} = 0\text{ V}^{3)}$
4.4.11	Quiescent Current	$I_{QSE}$	–	180	300	$\mu\text{A}$	$I_{OUT} = 0.3\text{ mA}$
4.4.12	Quiescent Current	$I_Q$	–	–	3.6	mA	$I_{OUT} = 100\text{ mA}$

1)  $V_{IN} = 40\text{ V}$  may be only applied as transient supply voltage to the device for maximum period of  $t_{TR} < 1\text{ s}$ . Please note that also for such transient conditions, especially under higher load conditions, the absolute maximum rating of  $T_J$  must be respected at any time. If transient conditions up to  $V_{IN} = 40\text{ V}$  and elevated load currents are expected in the application a sufficient cooling must be provided to meet the power dissipation. Testing this parameter for the maximum allowed period of  $T = 1\text{ s}$  is for thermal reasons not subject to production test but guaranteed by design.

2) The test of this parameter ensures that the output voltage will not exceed 5.5V in a corresponding “no load current”-condition. A sufficiently high value for  $I_{outh}$  will allow the output to react in a fast manner in case of a sudden decrease of load current (e.g. if load is switching to standby or powerdown mode) .

3) Foldback characteristic.



## 4.4.2 RESET

### Electrical Characteristics: Reset

$V_{IN} = 14\text{ V}$ ,  $T_j = -40\text{ °C}$  to  $+125\text{ °C}$ , all voltages with respect to ground, direction of current as shown in [Figure 3 “Application Diagram” on Page 14](#) (unless otherwise specified)

Pos.	Parameter	Symbol	Limit Values			Unit	Conditions
			Min.	Typ.	Max.		
4.4.13	Reset Threshold Voltage	$V_{RT}$	4.25	4.5	4.75	V	–
4.4.14	Reset Threshold Hysteresis	$V_{RTH}$	50	100	200	mV	–
4.4.15	Reset Pulse Delay	$t_{RD}$	55	100	180	ms	Calculated Value: $C_D = 100\text{nF}$ ; $t_R \geq 100\mu\text{s}$
4.4.16	Reset Output Low Voltage	$V_{RL}$	–	–	0.4	V	$R_{RES} \geq 10\text{k}\Omega$ to $V_{OUT}$ $V_{IN} \geq 0\text{V}$ and $V_{OUT} \geq 1\text{V}^{1)}$
4.4.17	Reset Output High Leakage Current	$I_{RH}$	–	–	1	$\mu\text{A}$	$V_{RES} = 5\text{V}$
4.4.18	Delay Comparator Threshold	$V_{D,th}$	–	2	–	V	–
4.4.19	Delay Comparator Threshold Hysteresis	$V_{D,th,hy}$	–	100	–	mV	–
4.4.20	Delay Capacitor charge current	$I_{D,chg}$	–	2	–	$\mu\text{A}$	$V_D = 1\text{V}$ ; current flowing out of D pin
4.4.21	Delay Capacitor discharge current	$I_{D,dchg}$	–	9	–	mA	$V_D = 1\text{V}$ ; current flowing into D pin

1) Device entering this condition by decreasing  $V_{IN}$  from powered up and fully initialized operation state.

## 4.4.3 Sense

### Electrical Characteristics: Sense

$V_{IN} = 14\text{ V}$ ,  $T_j = -40\text{ °C}$  to  $+125\text{ °C}$ , all voltages with respect to ground, direction of current as shown in [Figure 3 “Application Diagram” on Page 14](#) (unless otherwise specified)

Pos.	Parameter	Symbol	Limit Values			Unit	Conditions
			Min.	Typ.	Max.		
<b>Sense</b>							
4.4.22	Sense Low Threshold	$V_{ST}$	1.16	1.23	1.35	V	–
4.4.23	Sense Threshold Hysteresis	$V_{STH}$	20	100	200	mV	–
4.4.24	Sense Output Low Voltage	$V_{SL}$	–	–	0.4	V	$V_{SI} \leq 1.16\text{V}$ ; $V_{IN} \geq 3.5\text{V}$ ; $R_{SO} \geq 10\text{k}\Omega$ to $V_{OUT}$
4.4.25	Sense Output Leakage	$I_{SH}$	–	–	1	$\mu\text{A}$	$V_{SO} = 5\text{V}$ ; $V_{SI} \geq 1.5\text{V}$
4.4.26	Sense Input Current	$I_{SI}$	-5	-1.5	0	$\mu\text{A}$	$V_{SI} = 0$

#### 4.4.4 Preregulator

##### Electrical Characteristics: Preregulator

$V_{IN} = 14\text{ V}$ ,  $T_j = -40\text{ °C}$  to  $+125\text{ °C}$ , all voltages with respect to ground, direction of current as shown in [Figure 3 “Application Diagram” on Page 14](#) (unless otherwise specified)

Pos.	Parameter	Symbol	Limit Values			Unit	Conditions
			Min.	Typ.	Max.		
<b>Preregulator</b>							
4.4.27	Preregulator Output Voltage	$V_{PRE}$	4.5	5	6	V	$I_{PRE} = 10\ \mu\text{A}$
4.4.28	Preregulator Output Current	$I_{PRE}$	–	–	10	$\mu\text{A}$	–

## 4.5 Typical Performance Graphs

### Typical Performance Characteristics

Equivalent Series Resistance  $ESR(C_{OUT})$  versus Output Current  $I_{OUT}$

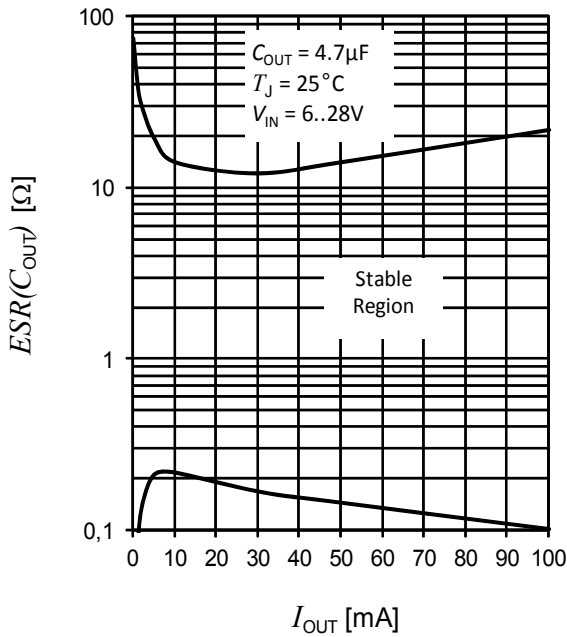

Output Voltage  $V_{OUT}$  versus Junction Temperature  $T_J$

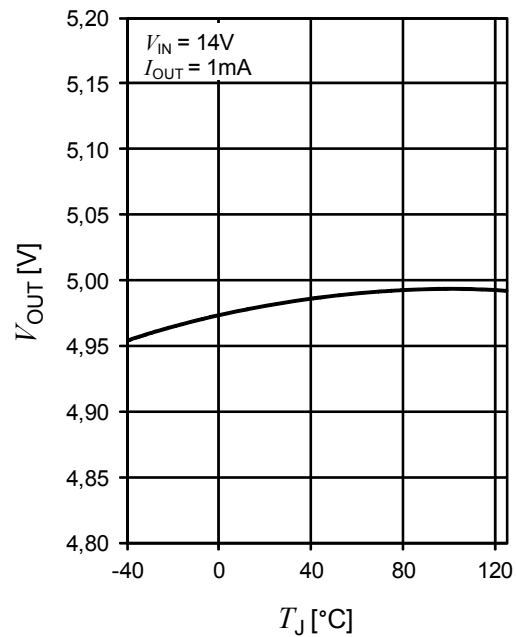

Output Voltage  $V_{OUT}$  versus Input Voltage  $V_{IN}$

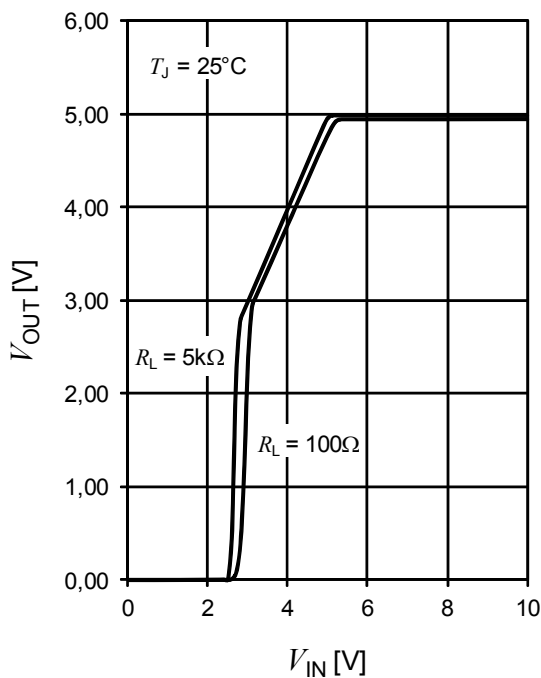

Dropout Voltage  $V_{DR}$  versus Output Current  $I_{OUT}$

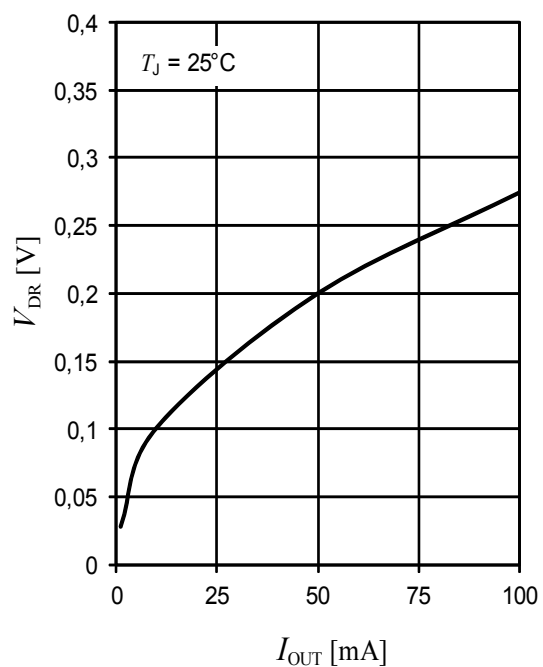

**Dropout Voltage  $V_{DR}$  versus Junction Temperature  $T_J$**

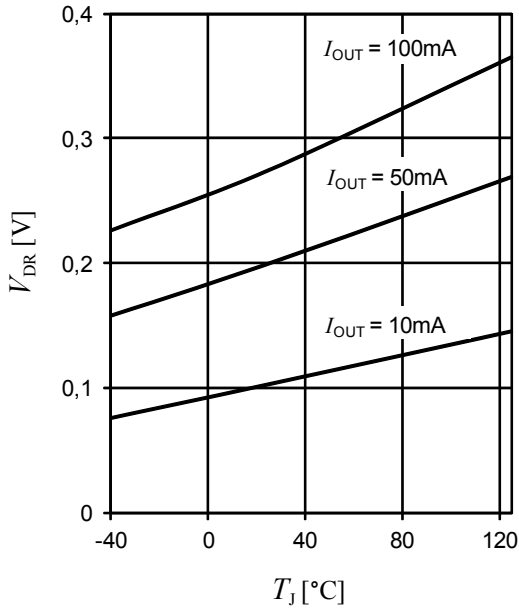

**Quiescent Current  $I_Q$  versus Output Current  $I_{OUT}$**

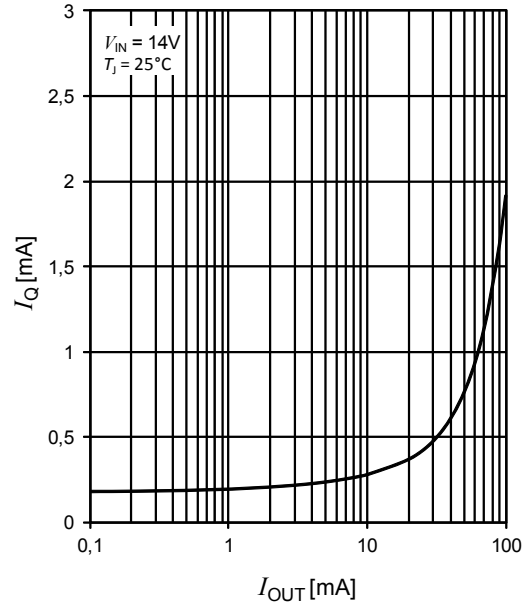

**Quiescent Current  $I_{QSE}$  versus Junction Temperature  $T_J$**

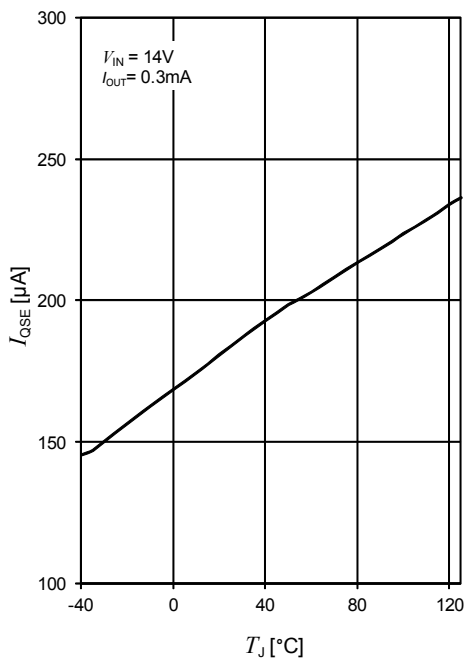

**Quiescent Current  $I_Q$  versus Input Voltage  $V_{IN}$**

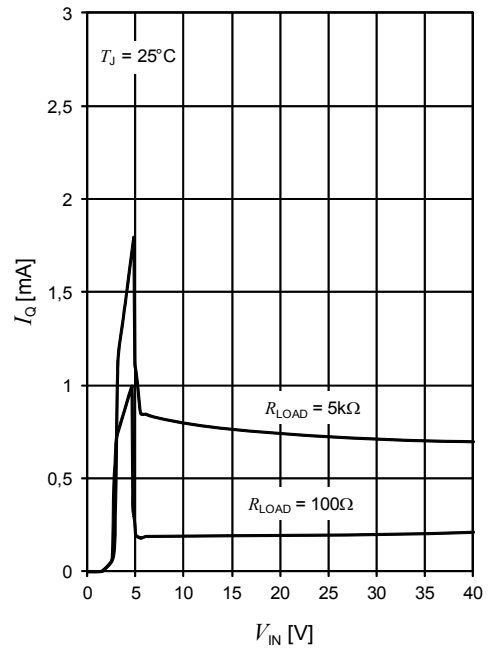

**Reset Output Voltage  $V_{RO}$  versus Regulator Output Voltage  $V_{OUT}$**

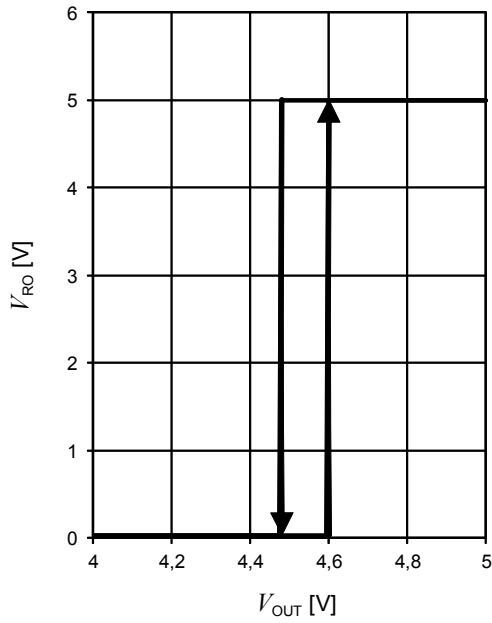

**Reset Thresholds  $V_{RT}$  versus Junction Temperature  $T_J$**

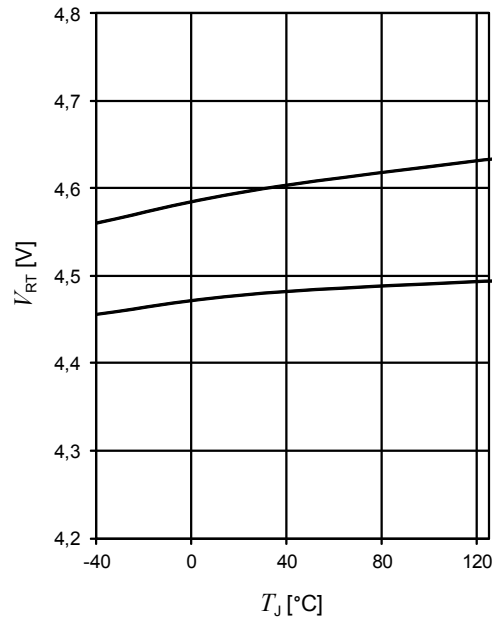

**Sense Output Voltage  $V_{SO}$  versus Sense Input Voltage  $V_{SI}$**

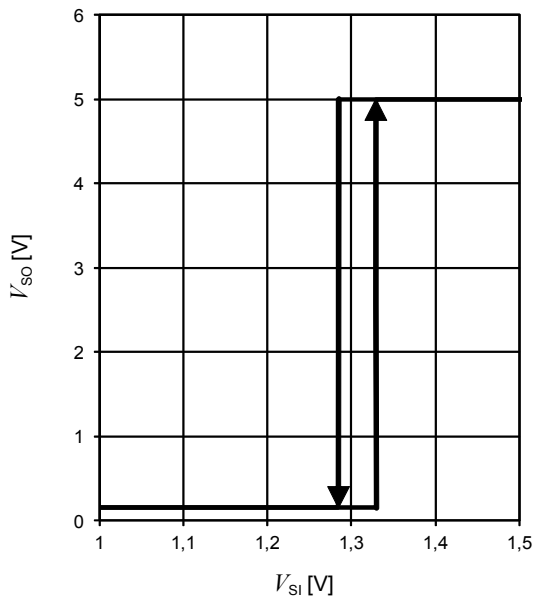

**Sense Thresholds  $V_{ST}$  versus Junction Temperature  $T_J$**

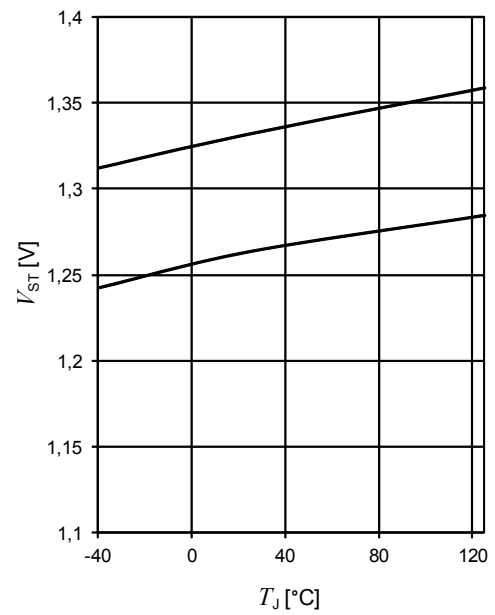

## 5 Application Information

*Note: The following information is given as a hint for the implementation of the device only and shall not be regarded as a description or warranty of a certain functionality, condition or quality of the device.*

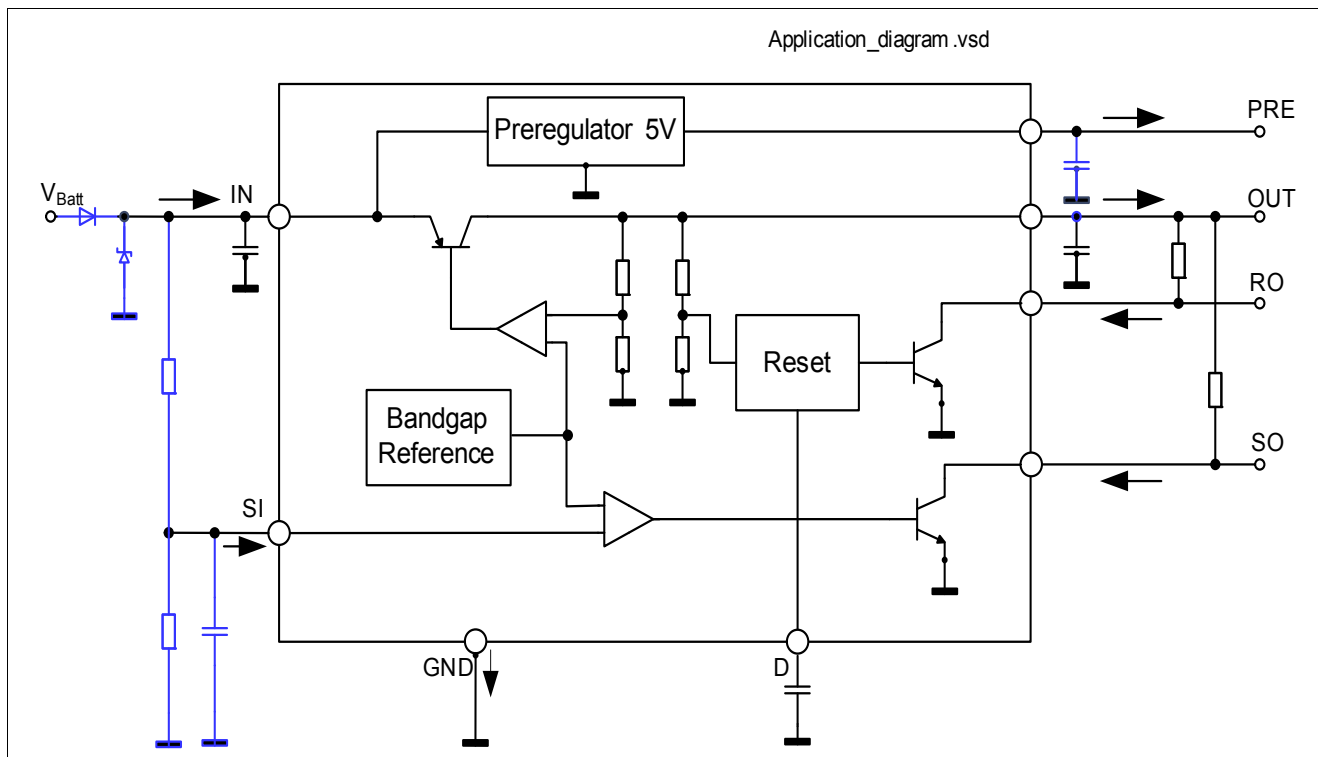

**Figure 3 Application Diagram**

*Note: This is a very simplified example of an application circuit. The function must be verified in the real application*

### 5.1 Supply Voltage Transients

For many other voltage regulators fast supply voltage transients can often be the cause of unwanted reset output signal perturbations. In contrast the IFX4949 shows a very high immunity of its reset output against such supply voltage transients. Already starting from input voltages as low as 5.5 V the IFX4949 shows an immunity of the reset output against supply transients of more than 100 V/ $\mu$ s even without an additional external capacitor at the PRE pin<sup>1) 2)</sup>.

### 5.2 Functional Description

#### Description

The IFX4949 is a monolithic integrated low dropout voltage regulator. Several outstanding features and auxiliary functions are implemented to meet the requirements of supplying microprocessor systems in all kinds of applications. The modular approach of this device allows to get easily also other features and functions when required.

1) Please note that also for the case of such input transients the absolute maximum ratings must not be violated.

2) The PRE pin of the IFX4949 offers the possibility to connect a bypass capacitor to GND to stabilize PRE output and to optimize the transient behaviour. See also section **“Preregulator”** on Page 16.

### Voltage Regulator

The voltage regulator uses a PNP transistor as a regulation element. With this structure a very low dropout voltage at currents of up to 100mA is obtained.

The dropout operation of the standby regulator is maintained down to 3.5V input supply voltage. The output voltage is regulated up to a transient input supply voltage of 40V. With this feature no functional interruption due to over voltage pulses is generated. The typical curve showing the standby output voltage as a function of the input supply voltage  $V_S$  is shown in [Figure 4 “Output Voltage vs. Input Voltage” on Page 15](#). Typical values of the current consumption of this device at small loads (quiescent current) are less than 200µA.

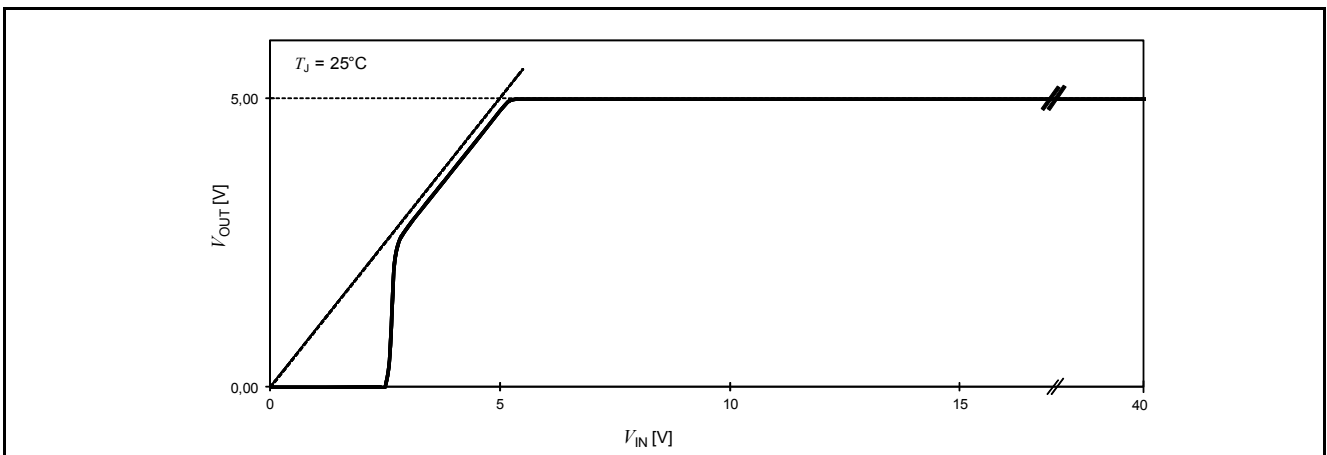

**Figure 4 Output Voltage vs. Input Voltage**

To reduce the quiescent current peak in the undervoltage region and to improve the transient response in this region, the dropout voltage is controlled. The quiescent current as a function of the supply input voltage is shown for two different load conditions in [Figure 5 “Quiescent Current vs. Supply Voltage” on Page 15](#).

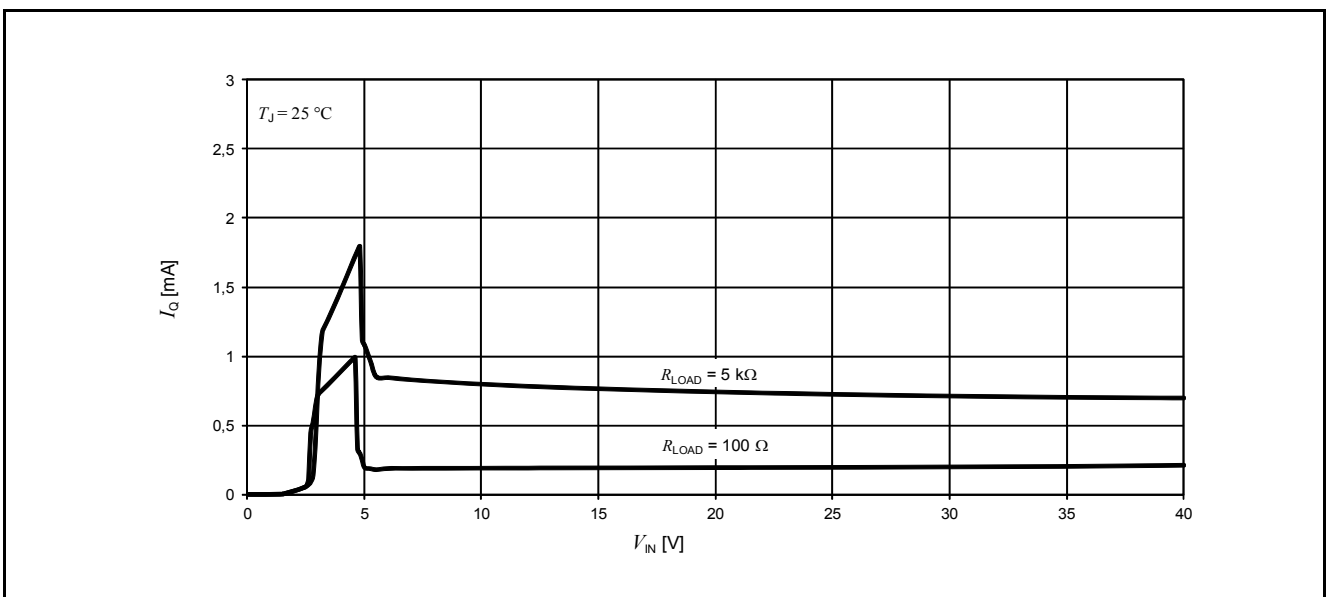

**Figure 5 Quiescent Current vs. Supply Voltage**

### Short Circuit Protection

The maximum output current of the device is internally limited. In case of short circuit, the output current is foldback limited as described in [Figure 6 “Foldback Characteristics of VOUT” on Page 16](#).

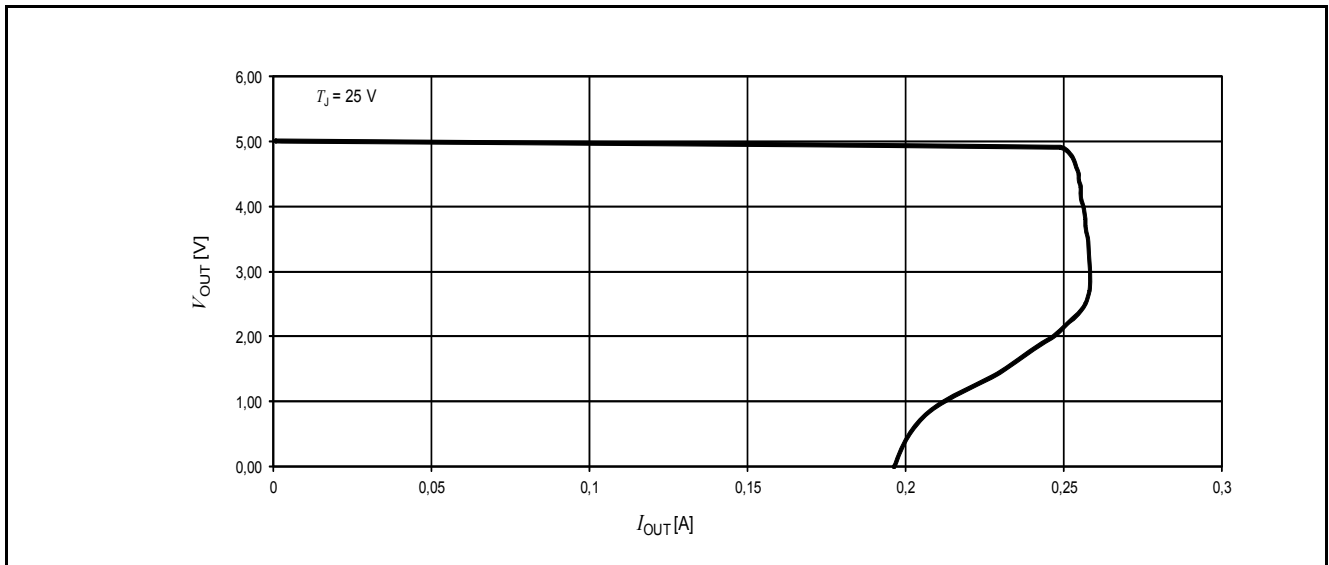

**Figure 6** Foldback Characteristics of  $V_{OUT}$

### Preregulator

To improve the transient immunity a preregulator stabilizes the internal supply voltage to 5V. This internal voltage is also present at the PRE pin (Pin 3). This voltage should not be used as an output because the output capability is very small ( $\leq 10 \mu\text{A}$ ).

This output at the PRE pin may be used as an option when an improved transient behavior for supply voltages less than 8V is desired. In this case a capacitor (100nF - 1 $\mu\text{F}$ ) can be connected between the PRE pin and GND. At the same time the usage of such a bypass capacitor is suitable to reduce output noise at the OUT pin. If this feature is not used the PRE pin must be left open.

### Reset Circuit

The block circuit diagram of the reset circuit is shown in [Figure 7 “Reset Circuit” on Page 17](#). The reset circuit supervises the output voltage. The reset threshold of 4.5V is defined by the internal reference voltage and standby output divider. The reset pulse delay time  $t_{RD}$ , is defined by the charge time of an external capacitor  $C_D$ :

$$t_{RD} = \frac{C_D \times 2.0 \text{ V}}{2.0 \mu\text{A}}$$

The reaction time of the reset circuit originates from the discharge time limitation of the reset capacitor  $C_D$  and is proportional to the value of  $C_D$ .



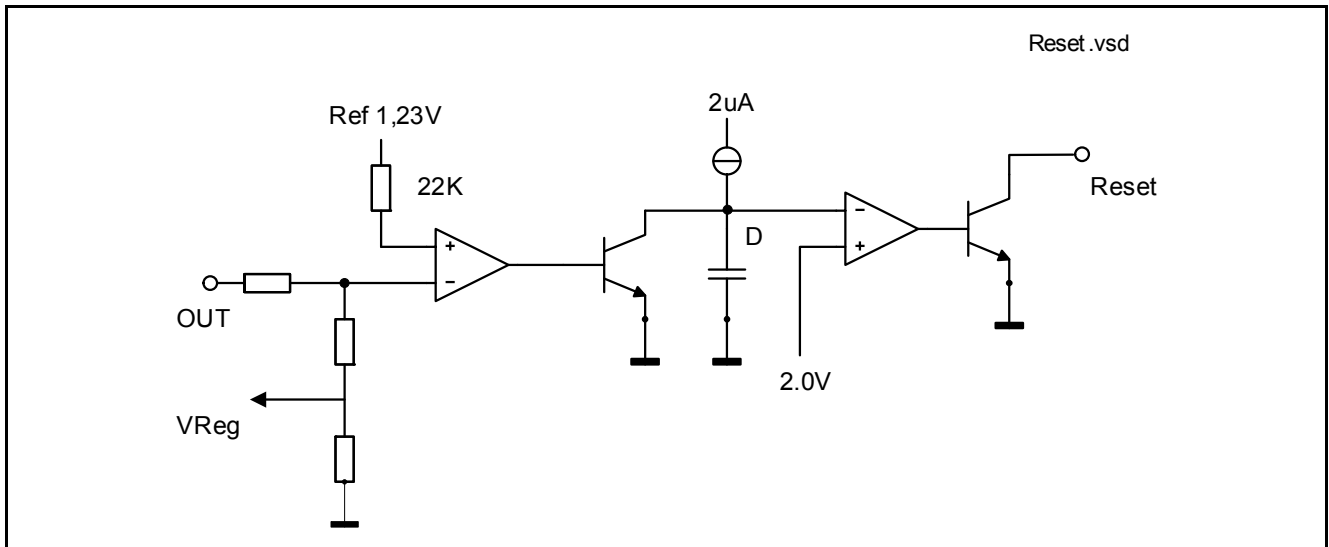

**Figure 7 Reset Circuit**

The reaction time of the reset circuit corresponds to its noise immunity. Standby output voltage drops below the reset threshold that are only marginally longer than the reaction time will result in a shorter reset delay times. The nominal reset delay time will be generated for standby output voltage drops longer than approximately 50µs. The typical reset output waveforms are shown in [Figure 8 “Typical Reset Output Waveforms” on Page 17](#).

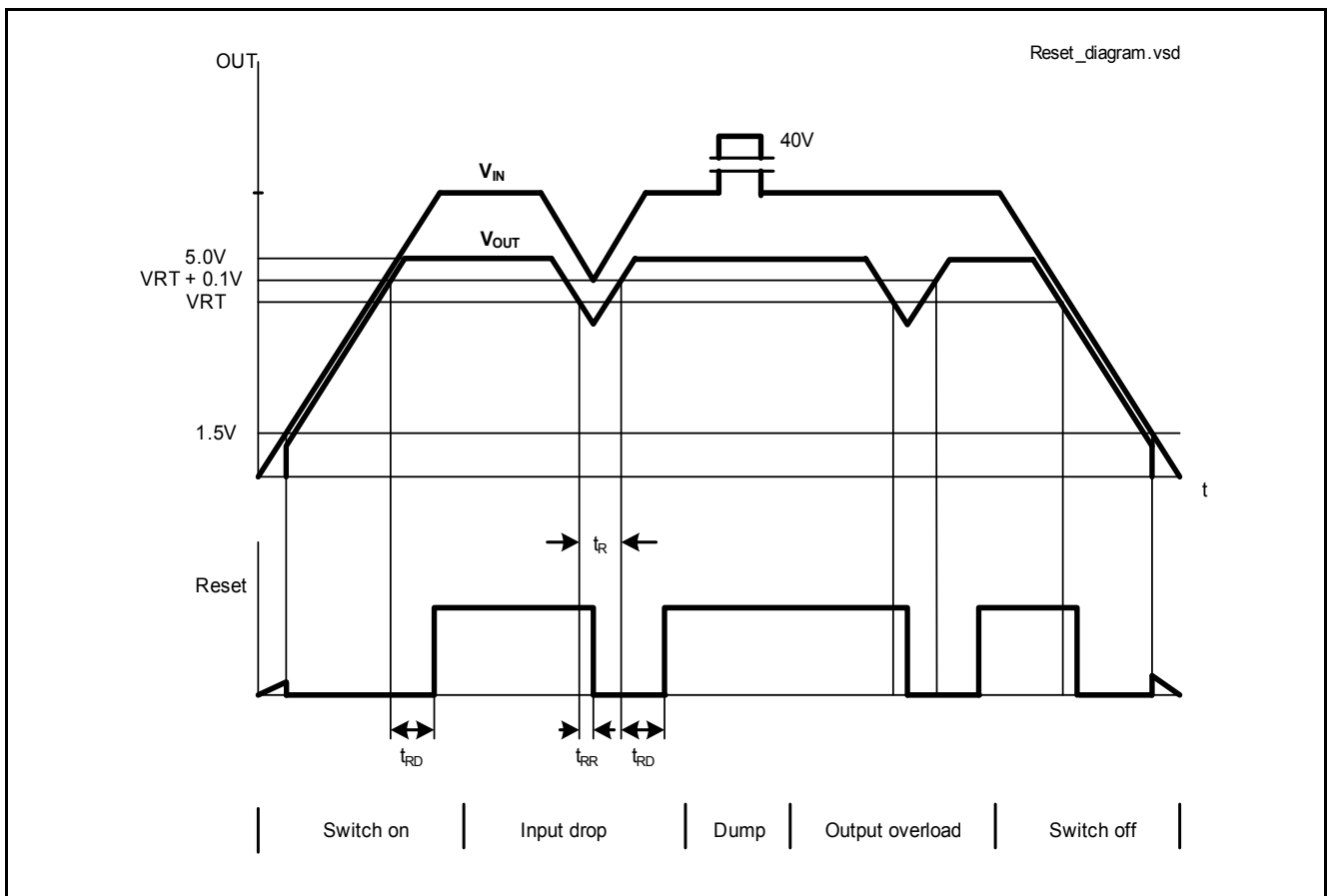

**Figure 8 Typical Reset Output Waveforms**

**Sense Comparator**

The sense comparator compares an input signal with the internal voltage reference of typical 1.23V. The use of an external voltage divider makes this comparator very flexible in the application.

It can be used to supervise the input voltage either before or after a protection diode and to give additional informations to the microprocessor like low voltage warnings.

## 6 Package Outlines

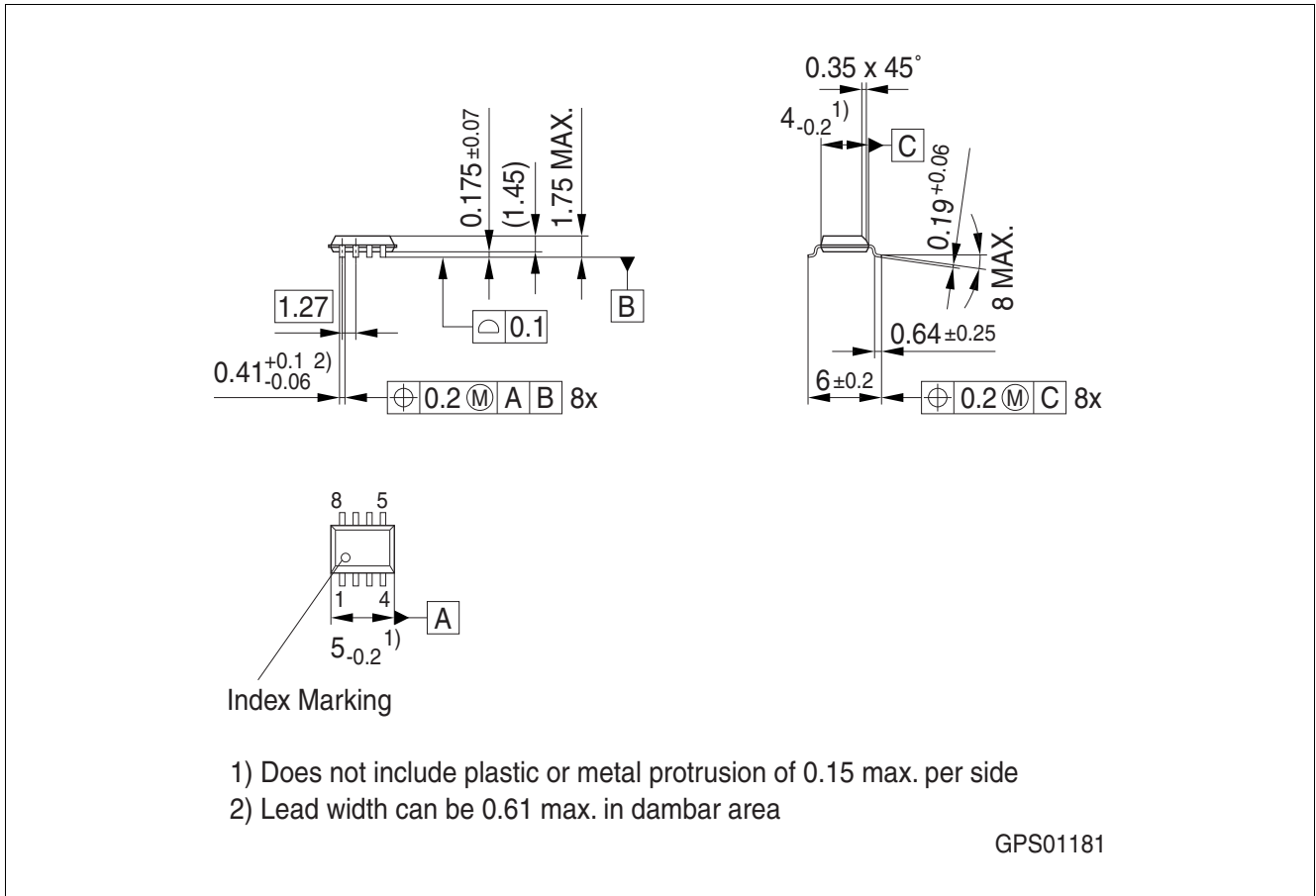

Figure 9 PG-DSO-8

### Green Product (RoHS compliant)

To meet the world-wide customer requirements for environmentally friendly products and to be compliant with government regulations the device is available as a green product. Green products are RoHS-Compliant (i.e Pb-free finish on leads and suitable for Pb-free soldering according to IPC/JEDEC J-STD-020).

## 7 Revision History

Revision	Date	Changes
1.0	2012-05-07	Data Sheet – Initial Release.

**Edition 2012-05-07**

**Published by  
Infineon Technologies AG  
81726 Munich, Germany**

**© 2012 Infineon Technologies AG  
All Rights Reserved.**

### **Legal Disclaimer**

The information given in this document shall in no event be regarded as a guarantee of conditions or characteristics. With respect to any examples or hints given herein, any typical values stated herein and/or any information regarding the application of the device, Infineon Technologies hereby disclaims any and all warranties and liabilities of any kind, including without limitation, warranties of non-infringement of intellectual property rights of any third party.

### **Information**

For further information on technology, delivery terms and conditions and prices, please contact the nearest Infineon Technologies Office ([www.infineon.com](http://www.infineon.com)).

### **Warnings**

Due to technical requirements, components may contain dangerous substances. For information on the types in question, please contact the nearest Infineon Technologies Office.

The Infineon Technologies component described in this Data Sheet may be used in life-support devices or systems and/or automotive, aviation and aerospace applications or systems only with the express written approval of Infineon Technologies, if a failure of such components can reasonably be expected to cause the failure of that life-support automotive, aviation and aerospace device or system or to affect the safety or effectiveness of that device or system. Life support devices or systems are intended to be implanted in the human body or to support and/or maintain and sustain and/or protect human life. If they fail, it is reasonable to assume that the health of the user or other persons may be endangered.