

### Dual IGBTMOD™ U-Series Module 300 Amperes/600 Volts

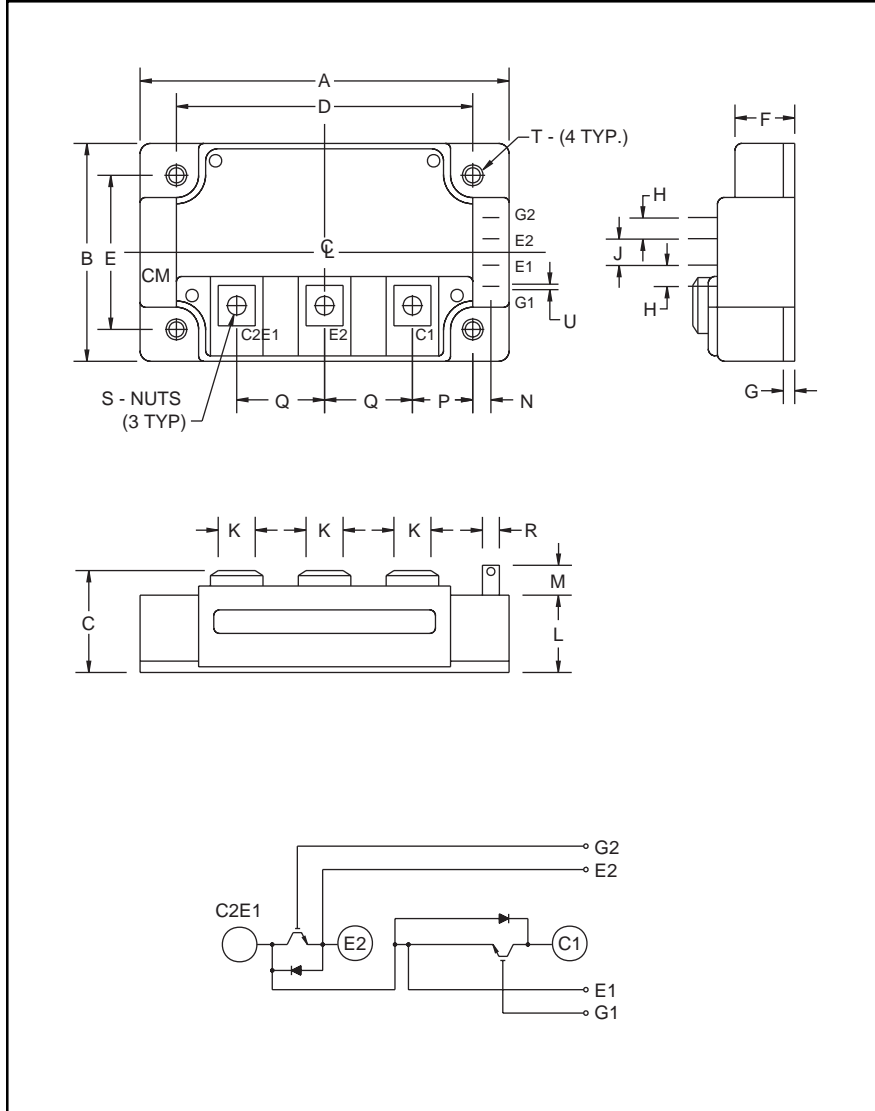

Outline Drawing and Circuit Diagram

Dimensions	Inches	Millimeters
A	4.25	108.0
B	2.44	62.0
C	1.14 +0.04/-0.02	29.0 +1.0/-0.5
D	3.66±0.01	93.0±0.25
E	1.88±0.01	48.0±0.25
F	0.67	17.0
G	0.16	4.0
H	0.24	6.0
J	0.59	15.0
K	0.55	14.0

Dimensions	Inches	Millimeters
L	0.87	22.0
M	0.33	8.5
N	0.10	2.5
P	0.85	21.5
Q	0.98	25.0
R	0.11	2.8
S	M6	M6
T	0.26 Dia.	6.5 Dia.
U	0.002	0.05



#### Description:

Powerex IGBTMOD™ Modules are designed for use in switching applications. Each module consists of two IGBT Transistors in a half-bridge configuration with each transistor having a reverse-connected super-fast recovery free-wheel diode. All components and interconnects are isolated from the heat sinking baseplate, offering simplified system assembly and thermal management.

#### Features:

- Low Drive Power
- Low  $V_{CE(sat)}$
- Discrete Super-Fast Recovery Free-Wheel Diode
- Isolated Baseplate for Easy Heat Sinking

#### Applications:

- AC Motor Control
- Motion/Servo Control
- UPS
- Welding Power Supplies
- Laser Power Supplies

#### Ordering Information:

Example: Select the complete module number you desire from the table - i.e. CM300DU-12H is a 600V ( $V_{CES}$ ), 300 Ampere Dual IGBTMOD™ Power Module.

Type	Current Rating Amperes	$V_{CES}$ Volts (x 50)
CM	300	12

**CM300DU-12H**  
**Dual IGBTMOD™ U-Series Module**  
 300 Amperes/600 Volts

**Absolute Maximum Ratings,  $T_j = 25^\circ\text{C}$  unless otherwise specified**

Ratings	Symbol	CM300DU-12H	Units
Junction Temperature	$T_j$	-40 to 150	$^\circ\text{C}$
Storage Temperature	$T_{\text{stg}}$	-40 to 125	$^\circ\text{C}$
Collector-Emitter Voltage (G-E SHORT)	$V_{\text{CES}}$	600	Volts
Gate-Emitter Voltage (C-E SHORT)	$V_{\text{GES}}$	$\pm 20$	Volts
Collector Current ( $T_c = 25^\circ\text{C}$ )	$I_c$	300	Amperes
Peak Collector Current ( $T_j \leq 150^\circ\text{C}$ )	$I_{\text{CM}}$	600*	Amperes
Emitter Current** ( $T_c = 25^\circ\text{C}$ )	$I_E$	300	Amperes
Peak Emitter Current**	$I_{\text{EM}}$	600*	Amperes
Maximum Collector Dissipation ( $T_c = 25^\circ\text{C}$ )	$P_c$	890	Watts
Mounting Torque, M6 Main Terminal	–	40	in-lb
Mounting Torque, M6 Mounting	–	40	in-lb
Weight	–	400	Grams
Isolation Voltage (Main Terminal to Baseplate, AC 1 min.)	$V_{\text{iso}}$	2500	Volts

\* Pulse width and repetition rate should be such that the device junction temperature ( $T_j$ ) does not exceed  $T_{j(\text{max})}$  rating.

\*\*Represents characteristics of the anti-parallel, emitter-to-collector free-wheel diode (FWDi).

**Static Electrical Characteristics,  $T_j = 25^\circ\text{C}$  unless otherwise specified**

Characteristics	Symbol	Test Conditions	Min.	Typ.	Max.	Units
Collector-Cutoff Current	$I_{\text{CES}}$	$V_{\text{CE}} = V_{\text{CES}}, V_{\text{GE}} = 0\text{V}$	–	–	1	mA
Gate Leakage Voltage	$I_{\text{GES}}$	$V_{\text{GE}} = V_{\text{GES}}, V_{\text{CE}} = 0\text{V}$	–	–	0.5	$\mu\text{A}$
Gate-Emitter Threshold Voltage	$V_{\text{GE(th)}}$	$I_c = 30\text{mA}, V_{\text{CE}} = 10\text{V}$	4.5	6	7.5	Volts
Collector-Emitter Saturation Voltage	$V_{\text{CE(sat)}}$	$I_c = 300\text{A}, V_{\text{GE}} = 15\text{V}, T_j = 25^\circ\text{C}$	–	2.4	3.0	Volts
		$I_c = 300\text{A}, V_{\text{GE}} = 15\text{V}, T_j = 125^\circ\text{C}$	–	2.6	–	Volts
Total Gate Charge	$Q_G$	$V_{\text{CC}} = 300\text{V}, I_c = 300\text{A}, V_{\text{GE}} = 15\text{V}$	–	600	–	nC
Emitter-Collector Voltage*	$V_{\text{EC}}$	$I_E = 300\text{A}, V_{\text{GE}} = 0\text{V}$	–	–	2.6	Volts

\* Pulse width and repetition rate should be such that the device junction temperature ( $T_j$ ) does not exceed  $T_{j(\text{max})}$  rating.

**Dynamic Electrical Characteristics,  $T_j = 25^\circ\text{C}$  unless otherwise specified**

Characteristics	Symbol	Test Conditions	Min.	Typ.	Max.	Units	
Input Capacitance	$C_{\text{ies}}$		–	–	26.4	nf	
Output Capacitance	$C_{\text{oes}}$	$V_{\text{CE}} = 10\text{V}, V_{\text{GE}} = 0\text{V}$	–	–	14.4	nf	
Reverse Transfer Capacitance	$C_{\text{res}}$		–	–	4	nf	
Resistive	Turn-on Delay Time	$t_{\text{d(on)}}$	$V_{\text{CC}} = 300\text{V}, I_c = 300\text{A},$	–	–	250	ns
	Load						
Switch	Turn-off Delay Time	$t_{\text{d(off)}}$	$R_G = 2.1\Omega, \text{Resistive}$	–	–	350	ns
Times	Fall Time	$t_f$	Load Switching Operation	–	–	300	ns
Diode Reverse Recovery Time	$t_{\text{rr}}$	$I_E = 300\text{A}, di_E/dt = -600\text{A}/\mu\text{s}$	–	–	160	ns	
Diode Reverse Recovery Charge	$Q_{\text{rr}}$	$I_E = 300\text{A}, di_E/dt = -600\text{A}/\mu\text{s}$	–	0.72	–	$\mu\text{C}$	

**Thermal and Mechanical Characteristics,  $T_j = 25^\circ\text{C}$  unless otherwise specified**

Characteristics	Symbol	Test Conditions	Min.	Typ.	Max.	Units
Thermal Resistance, Junction to Case	$R_{\text{th(j-c)Q}}$	Per IGBT 1/2 Module	–	–	0.14	$^\circ\text{C}/\text{W}$
Thermal Resistance, Junction to Case	$R_{\text{th(j-c)D}}$	Per FWDi 1/2 Module	–	–	0.24	$^\circ\text{C}/\text{W}$
Contact Thermal Resistance	$R_{\text{th(c-f)}}$	Per Module, Thermal Grease Applied	–	0.020	–	$^\circ\text{C}/\text{W}$

**CM300DU-12H**  
**Dual IGBTMOD™ U-Series Module**  
 300 Amperes/600 Volts

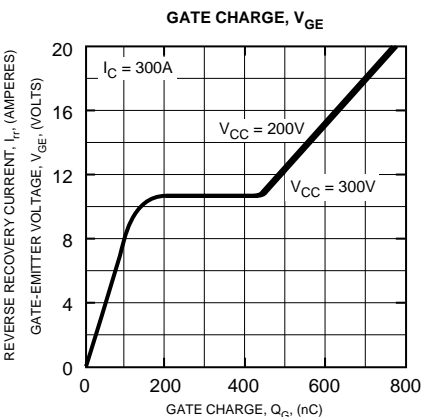
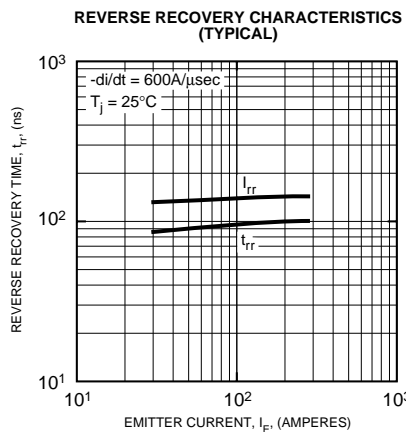
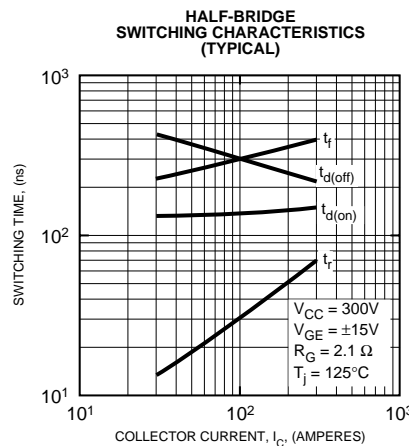
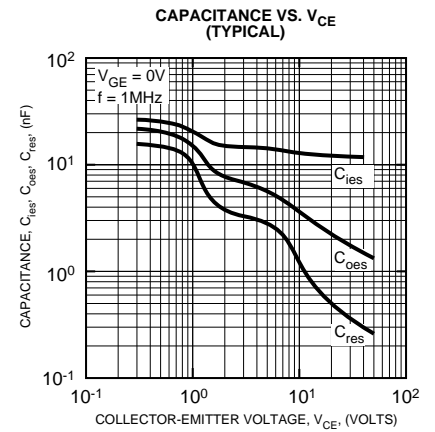
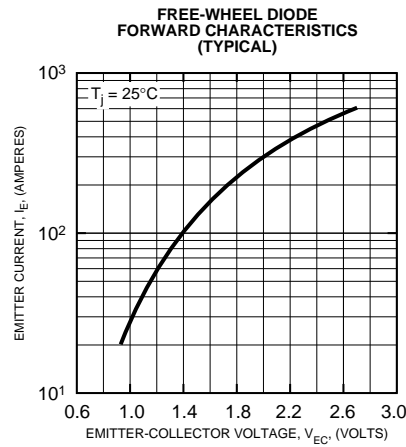
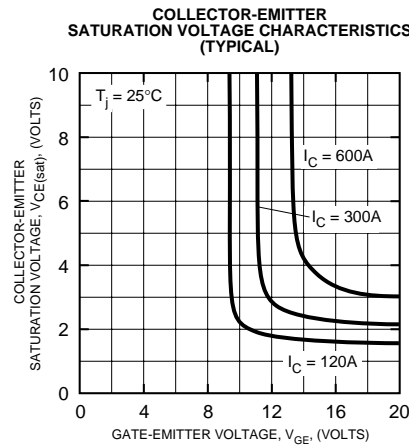
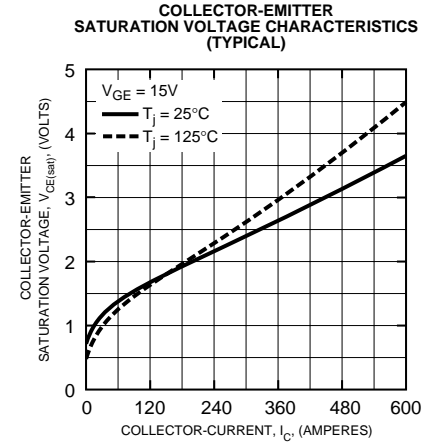
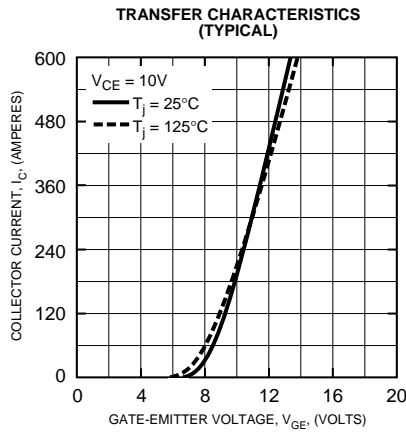
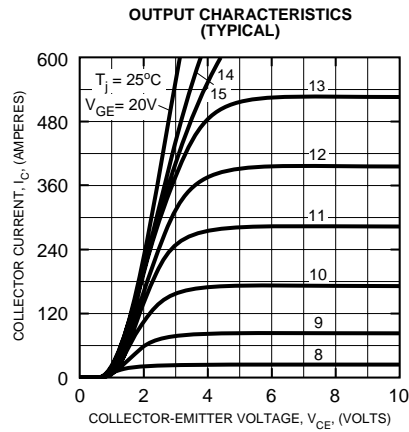

**CM300DU-12H**  
**Dual IGBTMOD™ U-Series Module**  
 300 Amperes/600 Volts

