

CKCM25X8R1H681M060AK

TDK Item Description : CKCM25X8R1H681MT***S



Application & Main Feature

Commercial Grade (2 in 1 Array)

Series

CKCM25

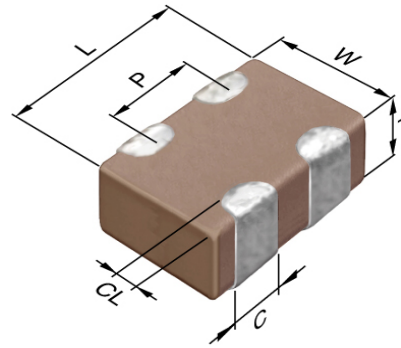

Dimensions

L	1.37mm +/-0.15mm
W	1.00mm +/-0.15mm
T	0.60mm +/-0.1mm
C	0.36mm Nom.
P	0.64mm Nom.

Temperature Characteristic

X8R (-55 to 150 degC +/-15%)

Rated Voltage

1H (50Vdc)

Capacitance

680pF

Capacitance Tolerance

M (+/-20%)

Dissipation Factor

3% Max.

Insulation Resistance

10Gohm Min.

AEC-Q200

Not Applicable

DC Bias Characteristic

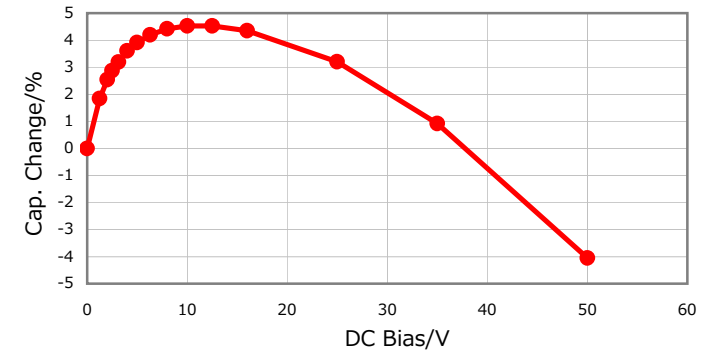

|Z|, ESR vs. Freq. Characteristics

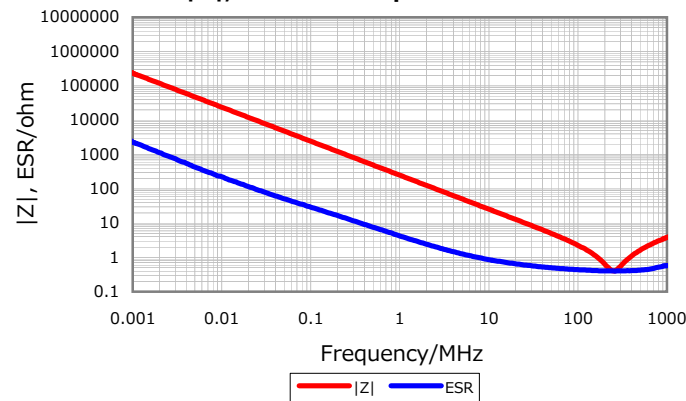

Temperature Characteristics

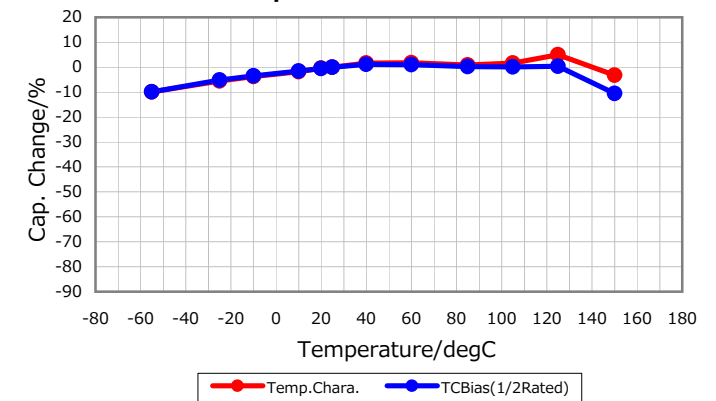

Cap. vs. Freq. Characteristic

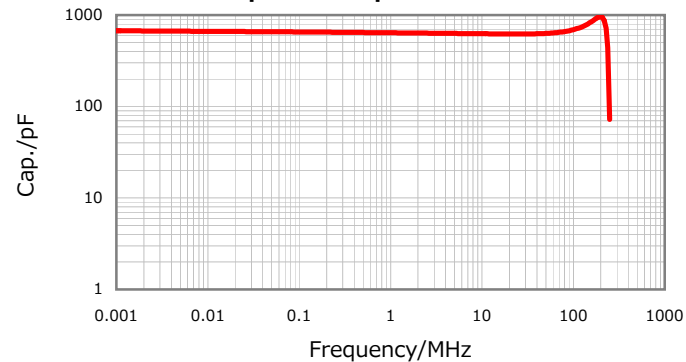

Ripple Temperature Rise Characteristics

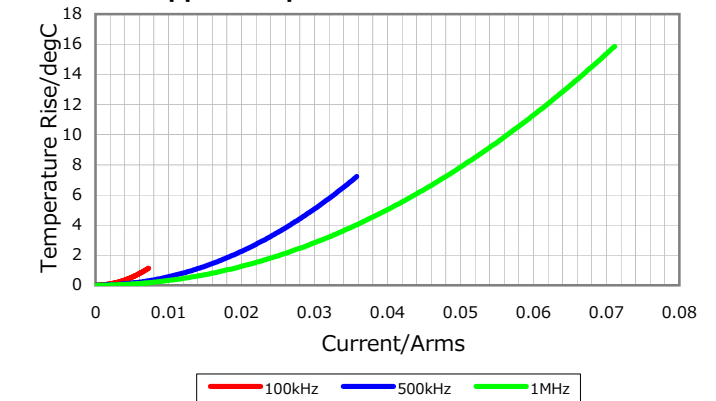

Characterization Sheet (Multilayer Ceramic Chip Capacitors)



All specifications are subject to change without notice.

January 4, 2016