

PROTECTION PRODUCTS - RailClamp[®]

Description

RClamp[®]0542Z is an ultra low capacitance ESD protection device designed to protect two high-speed lines in an 0201 footprint. This revolutionary package design reduces board space requirements by more than 50% over existing single line solutions. RClamp0542Z is a three pin device with identical low capacitance TVS diodes connected to each pin. Any two pins may be connected to high-speed lines, while the third pin is connected to ground. This gives the designer maximum flexibility in pcb routing. Each line has a maximum capacitance of only 0.30pF allowing it to be used on circuits operating in excess of 6GHz without appreciable signal attenuation.

RClamp0542Z is in a 3-pin SLP0603P3X3A package. It measures 0.62 x 0.32 mm with a nominal height of only 0.25mm. Leads partially extend up the side of the package for ease of soldering and are finished with lead-free NiAu. The combination of small size and high ESD surge capability makes them ideal for use in portable applications such as cellular phones, digital cameras, and tablets.

Features

- ◆ High ESD withstand Voltage: **+/-10kV** (Contact) and **+/- 15kV** (Air) per **IEC 61000-4-2**
- ◆ Able to withstand over 1000 ESD strikes per IEC 61000-4-2 Level 4
- ◆ Ultra-small **0201 package**
- ◆ Protects two high-speed data lines
- ◆ Low reverse current: <1nA typical (VR=5V)
- ◆ Working voltage: 5V
- ◆ Low capacitance: 0.30pF maximum
- ◆ Dynamic resistance: 0.67 Ohms (Typ)
- ◆ Solid-state silicon-avalanche technology

Mechanical Characteristics

- ◆ SLP0603P3X3A package
- ◆ Pb-Free, Halogen Free, RoHS/WEEE Compliant
- ◆ Nominal Dimensions: 0.6 x 0.3 x 0.25 mm
- ◆ Lead Finish: NiAu
- ◆ Molding compound flammability rating: UL 94V-0
- ◆ Marking: Marking code + dot matrix date code
- ◆ Packaging: Tape and Reel

Applications

- ◆ MIPI / MDDI
- ◆ Thunderbolt
- ◆ USB 3.0
- ◆ eSATA
- ◆ HDMI
- ◆ eDP
- ◆ MHL

Nominal Dimensions

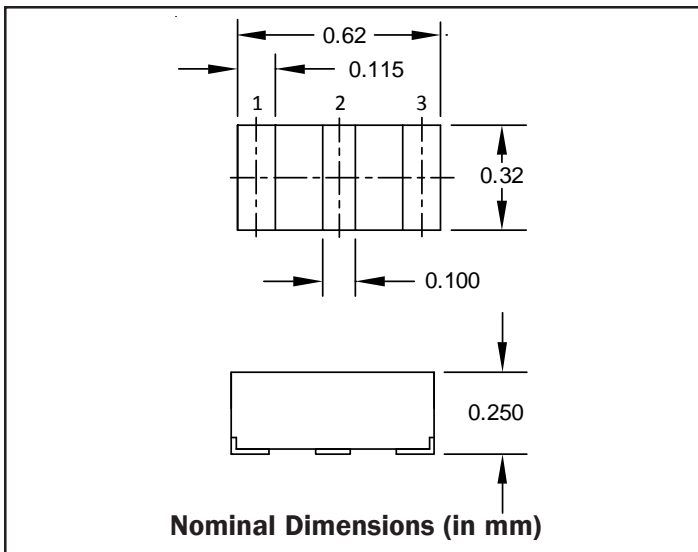

Schematic

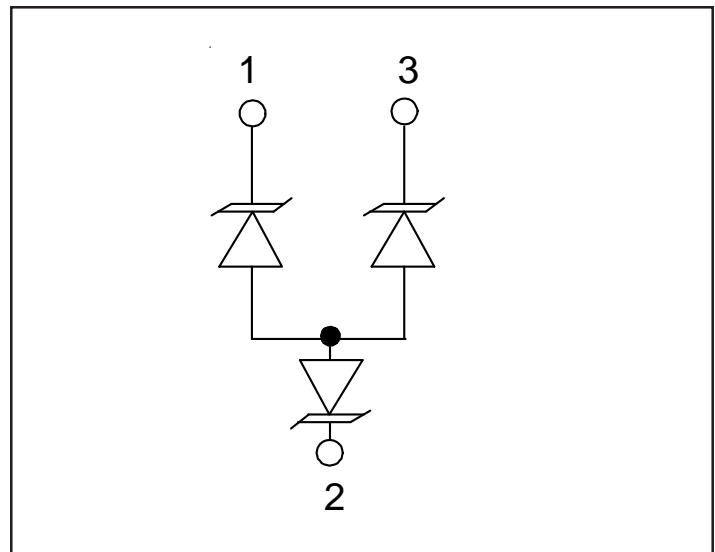

PROTECTION PRODUCTS
Absolute Maximum Rating

Rating	Symbol	Value	Units
Peak Pulse Power (tp = 8/20μs)	Ppk	30	Watts
Peak Pulse Current (tp = 8/20μs)	IPP	2	A
ESD per IEC 61000-4-2 (Air) ¹ ESD per IEC 61000-4-2 (Contact) ¹	V _{ESD}	+/- 15 +/- 10	kV
Operating Temperature	T _J	-55 to +125	°C
Storage Temperature	T _{STG}	-55 to +150	°C

Electrical Characteristics (T=25°C)

Parameter	Symbol	Conditions	Minimum	Typical	Maximum	Units
Reverse Stand-Off Voltage	V _{RWM}				5	V
Reverse Breakdown Voltage	V _{BR}	I _t = 1mA Between any 2 pins	7	9	11	V
Reverse Leakage Current	I _R	V _{RWM} = 5V, T=25°C Between any 2 pins		1	50	nA
Clamping Voltage	V _C	I _{pp} = 2A, tp = 8/20μs Between any 2 pins			15	V
ESD Clamping Voltage ²	V _C	I _{pp} = 4A, t _{lp} = 0.2/100ns Pin 1 to 2 or 3 to 2		12		V
ESD Clamping Voltage ²	V _C	I _{pp} = 16A, t _{lp} = 0.2/100ns Pin 1 to 2 or 3 to 2		20		V
Dynamic Resistance ^{2,3}	R _D	t _p = 100ns Pin 1 to 2 or 3 to 2		0.67		Ohms
Junction Capacitance	C _J	V _R = 0V to 5V, f = 1MHz Between any 2 pins		0.25	0.30	pF
Change in Capacitance Over V _R	ΔC _{JVR}	V _R = 0V to 5V, f = 1MHz			0.030	pF

Notes

1)ESD gun return path connected to ESD ground reference plane.

2)Transmission Line Pulse Test (TLP) Settings: t_p = 100ns, t_r = 0.2ns, I_{TLP} and V_{TLP} averaging window: t₁ = 70ns to t₂ = 90ns.

3) Dynamic resistance calculated from I_{TLP} = 4A to I_{TLP} = 16A

PROTECTION PRODUCTS

Typical Characteristics

Non-Repetitive Peak Pulse Power vs. Pulse Time

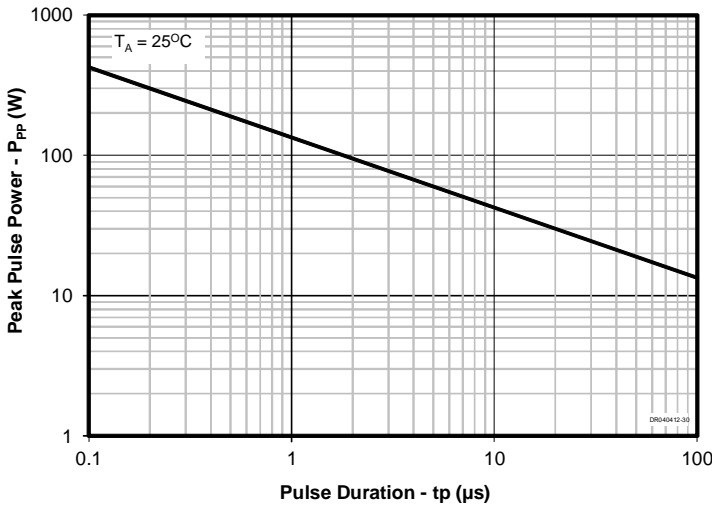

Clamping Voltage vs. Peak Pulse Current ($t_p=8/20\mu$ s)

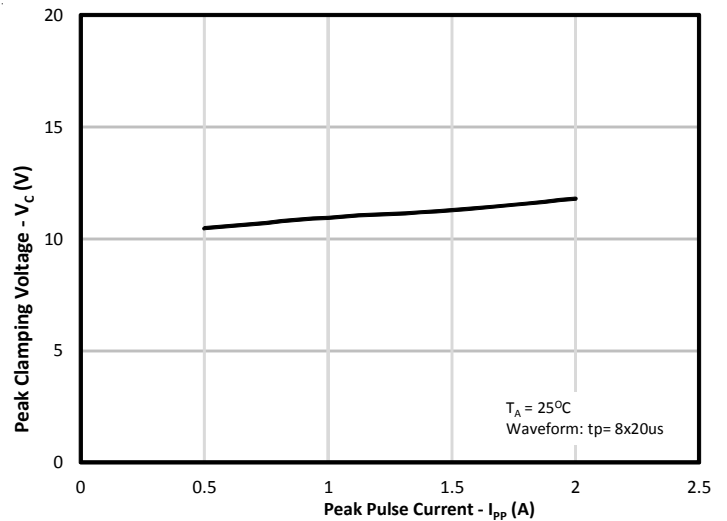

Junction Capacitance vs. Reverse Voltage

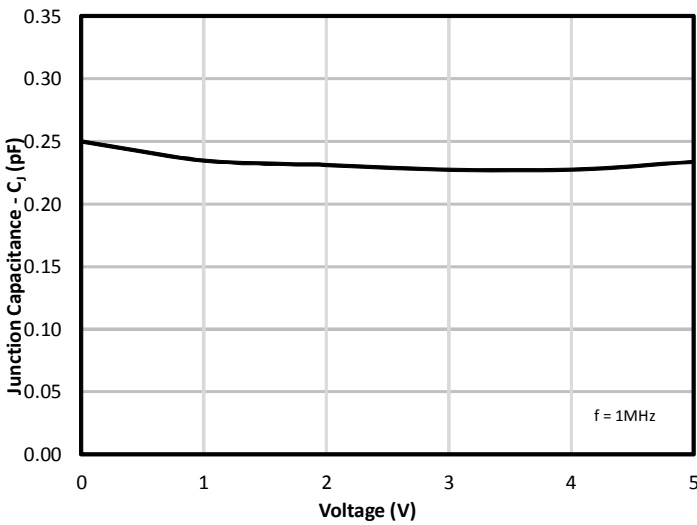

TLP Characteristic

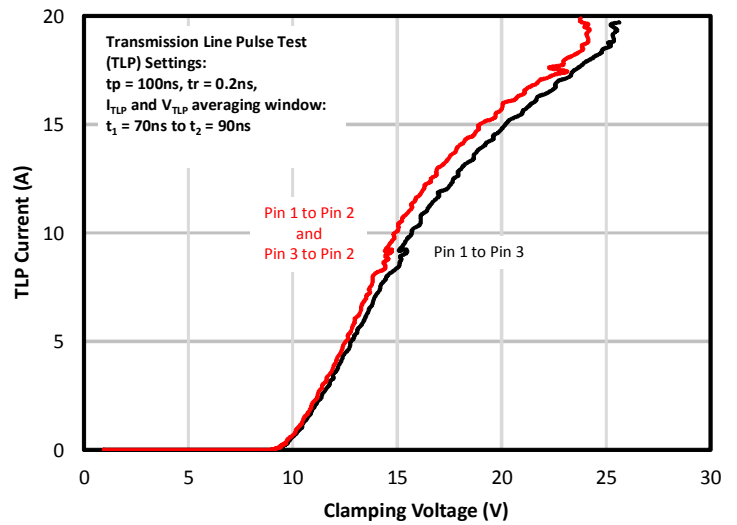

ESD Clamping (+8kV Contact per IEC 61000-4-2)

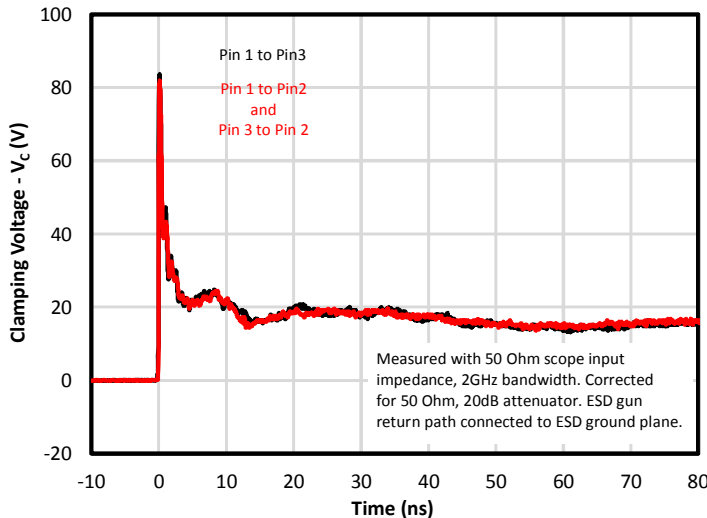

ESD Clamping (-8kV Contact per IEC 61000-4-2)

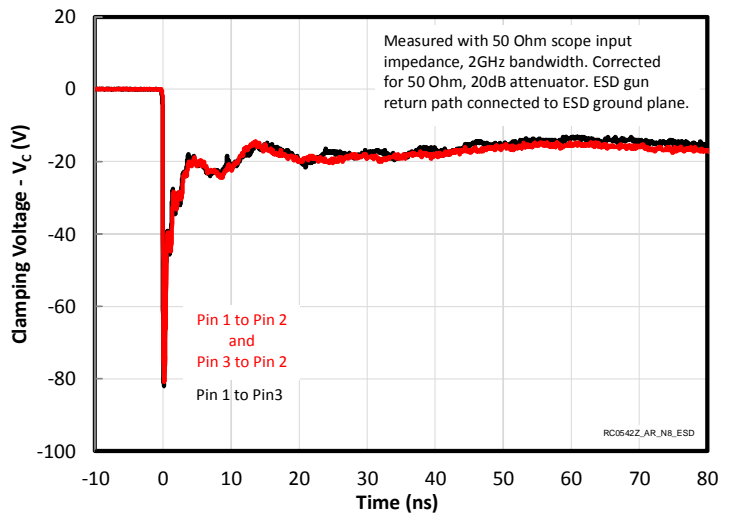

PROTECTION PRODUCTS

Typical Characteristics

Typical Insertion Loss S21

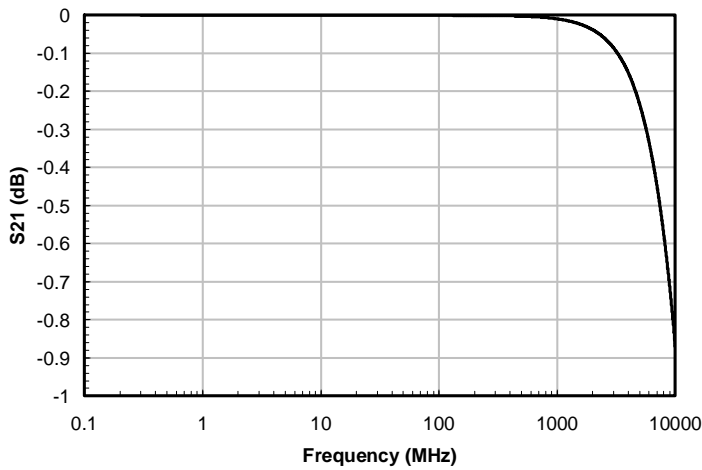

Analog Cross Talk

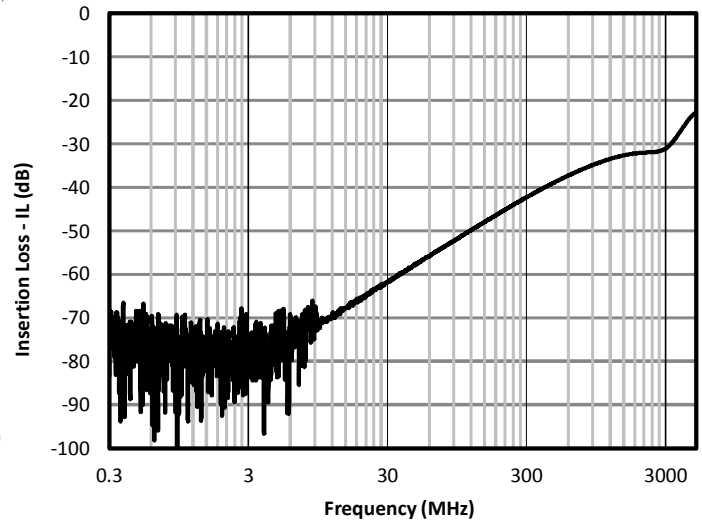





Applications Information

Assembly Guidelines

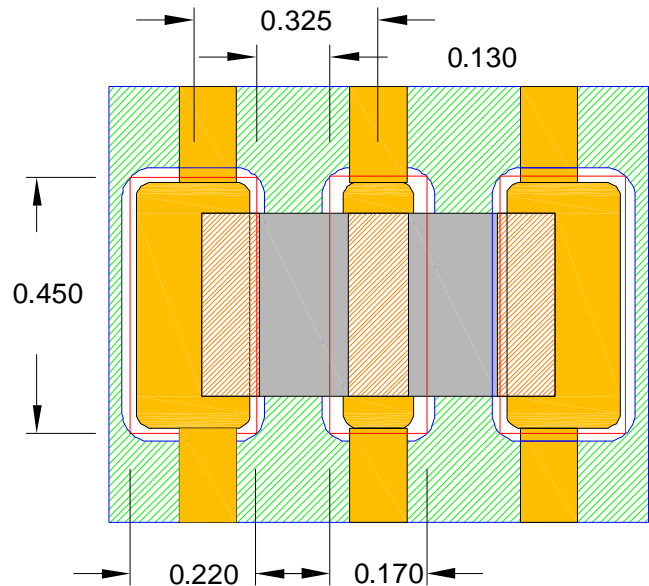
The small size of this device means that some care must be taken during the mounting process to insure reliable solder joints. The figure at the right details Semtech's recommended aperture based on the assembly guidelines detailed in the table below. Note that these are only recommendations and should serve only as a starting point for design since there are many factors that affect the assembly process. Exact manufacturing parameters will require some experimentation to get the desired solder application.

Assembly Parameter	Recommendation
Solder Stencil Design	Laser cut, Electro-polished
Aperture shape	Rectangular with rounded corners
Solder Stencil Thickness	0.100 mm (0.004")
Solder Paste Type	Type 4 size sphere or smaller
Solder Reflow Profile	Per JEDEC J-STD-020
PCB Solder Pad Design	Non-Solder mask defined
PCB Pad Finish	OSP OR NiAu



-  Stencil opening for solder print
-  Solder Mask
-  Land Pattern

All Dimensions are in mm

Recommended Mounting Pattern
(All dimensions are in mm)

PROTECTION PRODUCTS

Outline Drawing - SLP0603P3X3A

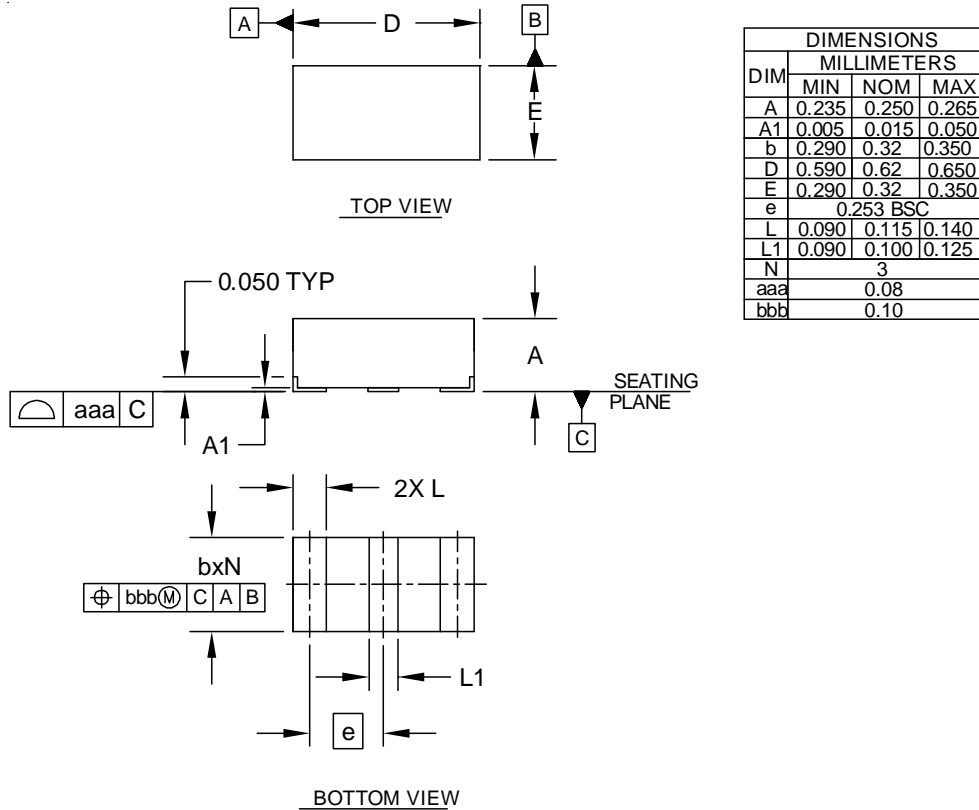

NOTES:
 1. CONTROLLING DIMENSIONS ARE IN MILLIMETERS(ANGLES IN DEGREES).

Land Pattern - SLP0603P3X3A

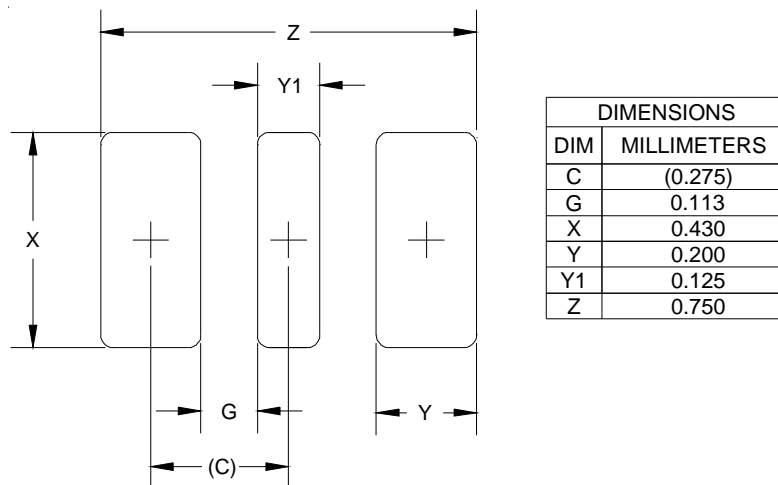

NOTES:
 1. CONTROLLING DIMENSIONS ARE IN MILLIMETERS (ANGLES IN DEGREES).
 2. THIS LAND PATTERN IS FOR REFERENCE PURPOSES ONLY.
 CONSULT YOUR MANUFACTURING GROUP TO ENSURE YOUR
 COMPANY'S MANUFACTURING GUIDELINES ARE MET.

PROTECTION PRODUCTS

Marking Code

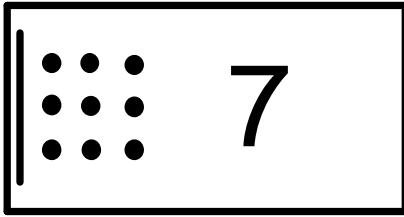

Ordering Information

Part Number	Qty per Reel	Pocket Pitch	Reel Size
RClamp0542Z.TFT	15,000	2mm	7 Inch

Notes:
 RailClamp and RClamp are trademarks of Semtech Corporation

Note:
 Device is electrically symmetrical

Carrier Tape Specification

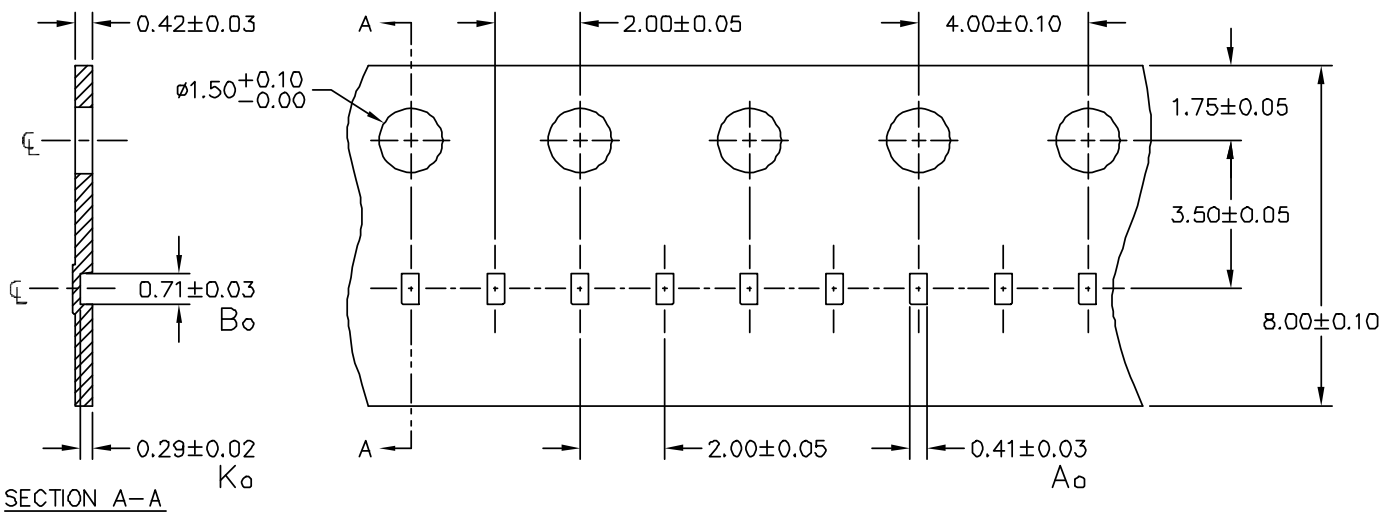

NOTES: ALL DIMENSIONS IN MILLIMETERS UNLESS OTHERWISE SPECIFIED.

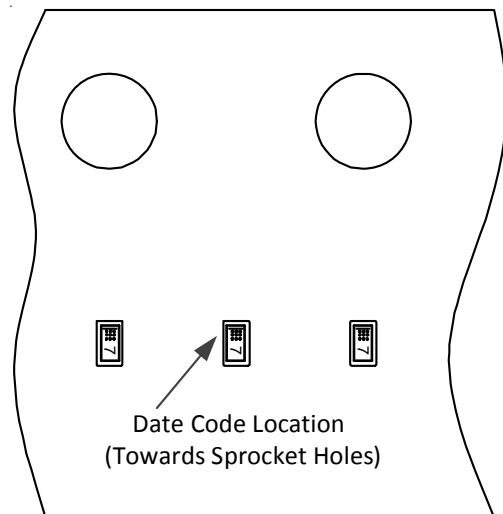

Device Orientation in Tape

Contact Information

Semtech Corporation
Protection Products Division
200 Flynn Rd., Camarillo, CA 93012
Phone: (805)498-2111 FAX (805)498-3804