



The Future of Analog IC Technology®

MP2678

Li-Ion Battery Charger Protection Circuit With LDO Mode

DESCRIPTION

The MP2678 is a high performance single cell Li-Ion/Li-Polymer battery charger protection IC. By integrating the high voltage input protection, the MP2678 can tolerate an input surge up to +30V.

The device operates like a linear regulator, maintaining a 5V output with the input voltage up to the over voltage protection threshold.

MP2678 features input over voltage protection (OVP), battery over voltage protection (BOVP) and over charge current protection (OCP). When any fault condition happens, the IC will immediately turn off the internal N-MOSFET to disconnect the charging circuit from the input. The device also provides fault indications to the system when any of the protection events happens.

For guaranteed safe operation, the MP2678 monitors its own internal temperature and turns off the internal N-MOSFET bridging IN and OUT when the die temperature exceeds 140°C.

The MP2678 is available in an 8-pin 2mm x 2mm QFN package.

FEATURES

- Input Surge up to 30V
- Input Over Voltage Protection
- Proprietary Battery Over-Voltage Protection
- Output Short-Circuit Protection
- Soft-Stop to Prevent Voltage Spikes
- Support up to 1.7A Load Current
- Thermal Monitoring and Protection
- Enable Function
- Fault Indication
- 2 mm×2mm QFN Package

APPLICATIONS

- Cell Phones
- Smart Phones
- PDAs
- MP3 Players
- Low-Power Handheld Devices

For MPS green status, please visit MPS website under Quality Assurance. "MPS" and "The Future of Analog IC Technology" are Registered Trademarks of Monolithic Power Systems, Inc.

TYPICAL APPLICATION CIRCUIT

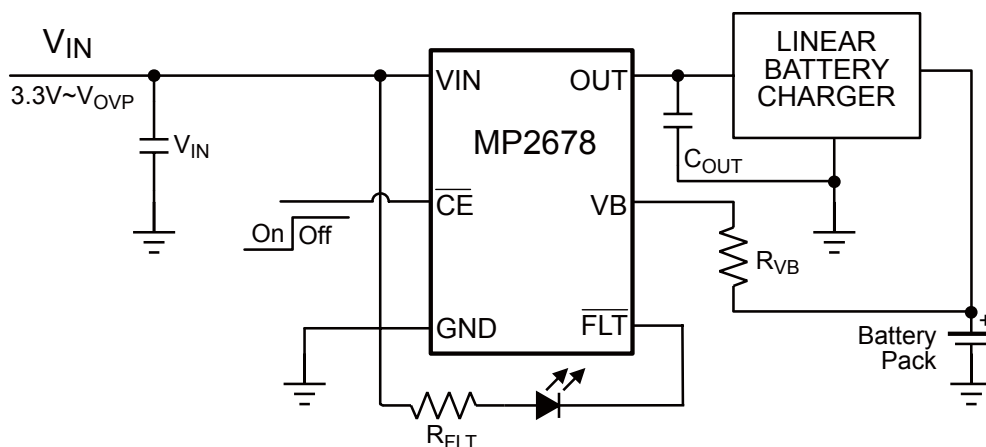

ORDERING INFORMATION

| Part Number* | V _{OVP} | Package | Top Marking | Free Air Temperature (T _A) |
|--------------|------------------|----------------|-------------|--|
| MP2678EG-104 | 10.4V | QFN8 (2mm×2mm) | AK | -20°C to +85°C |

*For different input OVP version, add suffix –XXX (e.g. MP2678EG-73 is 7.3V OVP)
Contact factory for availability.

For Tape & Reel, add suffix –Z (eg. MP2678EG–104–Z);
For RoHS, compliant packaging, add suffix –LF (eg. MP2678EG–104–LF–Z).

PACKAGE REFERENCE

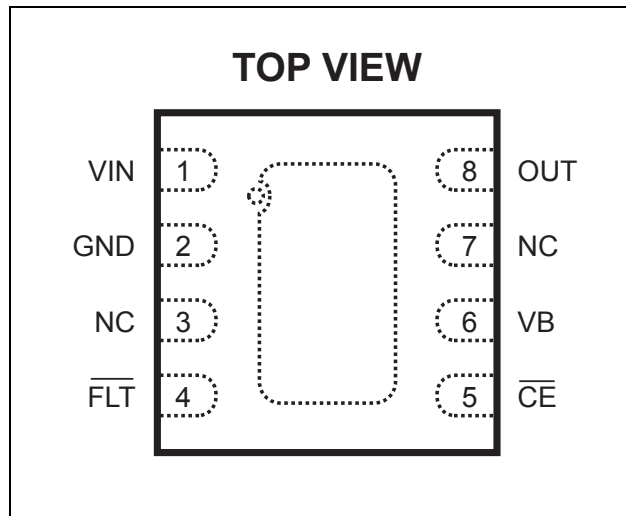

ABSOLUTE MAXIMUM RATINGS ⁽¹⁾

| | |
|--|----------------|
| VIN to GND | -0.3V to 30V |
| OUT to GND | -0.3V to 7V |
| Others to GND | -0.3V to 7V |
| Continuous Power Dissipation...(T _A = +25°C) ⁽²⁾ | 1.25W |
| Junction Temperature | -20°C to 150°C |
| Storage Temperature | -65°C to 150°C |

ESD Susceptibility ⁽³⁾

| | |
|-----------------------------|------|
| HBM (Human Body Mode) | 2kV |
| MM (Machine Mode) | 200V |

Recommended Operating Conditions ⁽⁴⁾

| | |
|--|--------------------------|
| Supply Input Voltage | 3.3V to V _{OVP} |
| Output Current | 1.5A |
| Maximum Junction Temp. (T _J) | +125°C |

| Thermal Resistance ⁽⁵⁾ | θ_{JA} | θ_{JC} |
|-----------------------------------|---------------|---------------|
| QFN8 2mm×2mm | 80 | 60... °C/W |

Notes:

- Exceeding these ratings may damage the device.
- The maximum allowable power dissipation is a function of the maximum junction temperature T_J (MAX), the junction-to-ambient thermal resistance θ_{JA} , and the ambient temperature T_A. The maximum allowable continuous power dissipation at any ambient temperature is calculated by P_D (MAX) = (T_J (MAX)-T_A)/ θ_{JA} . Exceeding the maximum allowable power dissipation will cause excessive die temperature, and the regulator will go into thermal shutdown. Internal thermal shutdown circuitry protects the device from permanent damage.
- Devices are ESD sensitive. Handling precaution recommended.
- The device is not guaranteed to function outside of its operating conditions.
- Measured on JESD51-7, 4-layer PCB.

ELECTRICAL CHARACTERISTICS

V_{IN}=5.5V, T_J= -20°C to 125°C, unless otherwise noted.

| Parameter | Symbol | Condition | Min | Typ | Max | Units |
|---|------------------------|--|------|------|------|-------|
| Power-On Reset | | | | | | |
| Output Voltage | V _{OUT} | 5.5V < V _{IN} < V _{OVP} , I _{OUT} =1mA | 4.6 | 5 | 5.4 | V |
| Rising VIN Threshold | V _{POR} | | 2.4 | | 2.8 | V |
| POR Hysteresis | | | | 150 | | mV |
| Supply Current | I _{IN} | CE is Low, V _{IN} =5V, No Load | | | 600 | μA |
| | | CE is high, V _{IN} =5.5V | | | 100 | μA |
| Input Power On Blanking Time | T _{REC(Vout)} | VIN Rising to OUT Rising | | 8 | | ms |
| Protection | | | | | | |
| Input Over-voltage Protection (OVP) | V _{OVP} | MP2678EG-104 | 9.9 | 10.4 | 10.8 | V |
| Input OVP Hysteresis | | | | 150 | | mV |
| Input OVP Propagation Delay ⁽⁶⁾ | | | | 1 | | μs |
| Input OVP Recovery Time | T _{REC(OVP)} | | | 8 | | ms |
| Over-current Protection | I _{OC} | 3V < V _{IN} < V _{OVP} | 1.2 | 1.5 | 1.7 | A |
| OCP Blanking Time | BT _{OC} | | | 170 | | μs |
| OCP Recovery Time | T _{REC(OC)} | | | 50 | | ms |
| Battery Over-voltage Protection Threshold | V _{BOVP} | | 4.23 | 4.35 | 4.5 | V |
| Battery OVP Hysteresis | | | | 150 | | mV |
| Battery OVP Blanking Time | BT _{BOVP} | | | 176 | | μs |
| VB Pin Leakage Current | | T _J =25°C | | | 100 | nA |
| Over Temperature Protection Rising Threshold | | | | 140 | 150 | °C |
| Over Temperature Protection Falling Threshold | | | | 20 | | °C |
| Logic | | | | | | |
| FLT Output Logic Low | | Sink 5mA current | | 0.2 | | V |
| FLT Output Logic High Leakage Current | | | | | 10 | μA |
| CE Logic Low Threshold | V _{IH} | | | | 0.4 | V |
| CE Logic High Threshold | V _{IL} | | 1.5 | | | V |
| Input to Output Characteristic | | | | | | |
| Dropout Voltage | V _{DO} | V _{IN} = V _{OUT(NOM)} - 0.1V, I _{OUT} =1A | | | 330 | mV |
| Q1 Off-state Leakage Current | I _{OFF} | CE is high, V _{IN} =5.5V | | | 10 | μA |

6) Guarantee by design

PIN FUNCTIONS

| QFN8 Pin # | Name | Description |
|---------------|-------------------------|--|
| 1 | VIN | Input Power Source. VIN can withstand 30V input. |
| 2 | GND Exposed Pad | System Ground. Connect exposed pad to GND plane for optimal thermal performance. |
| 3, 7 | NC | No Connect. Keep it float. |
| 4 | $\overline{\text{FLT}}$ | Open-Drain Logic Output. This pin turns LOW when any protection event occurs. |
| 5 | $\overline{\text{CE}}$ | Active-low enable pin. Pull $\overline{\text{CE}}$ pin below 0.4V to enable the IC. Drive $\overline{\text{CE}}$ pin higher than 1.5V to disable the IC |
| 6 | VB | Battery Voltage Monitoring Input. Connect this pin to the battery pack positive terminal via an isolation resistor. |
| 8 | OUT | Output pin. It is the input pin of the protected charger. |

TYPICAL PERFORMANCE CHARACTERISTICS

$V_{IN}=6V$, $V_{BAT}=GND$, $R_{VB}=10k\Omega$, $R_{FLT}=6.04k\Omega$, $C_{IN}=1\mu F$, $C_{OUT}=1\mu F$, $T_A=25^{\circ}C$, unless otherwise noted.
Supply Current vs. V_{IN} **Breakdown Voltage** **ACIN to OUT On Resistance vs. I_{OUT}**

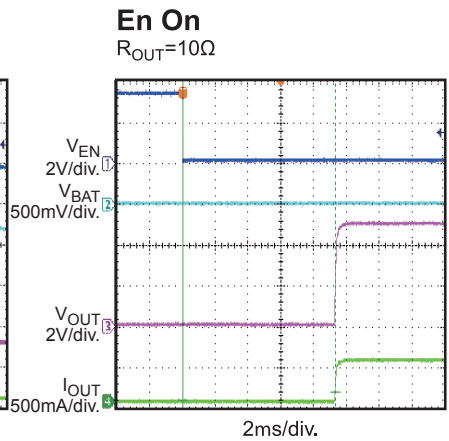
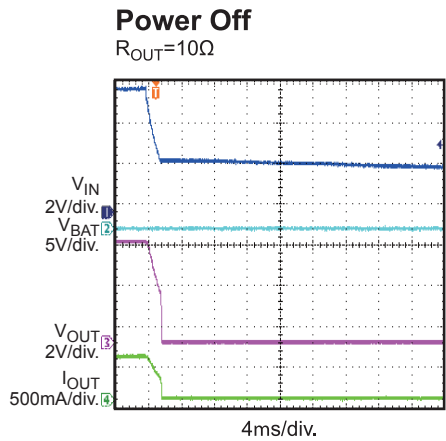
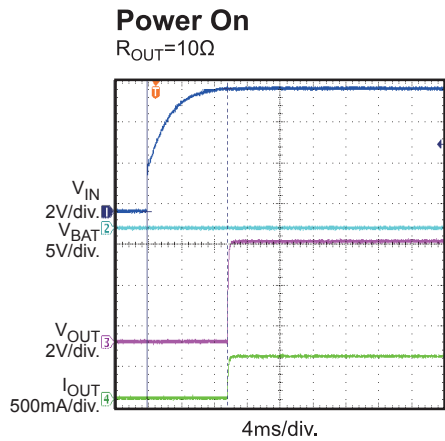
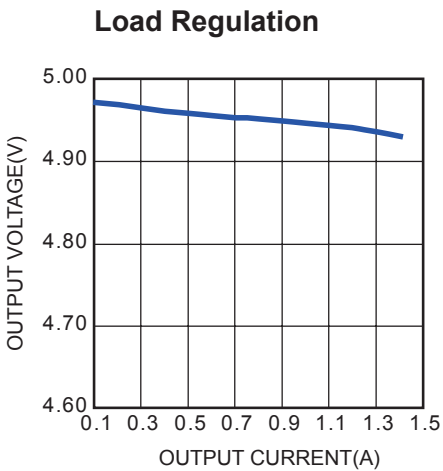
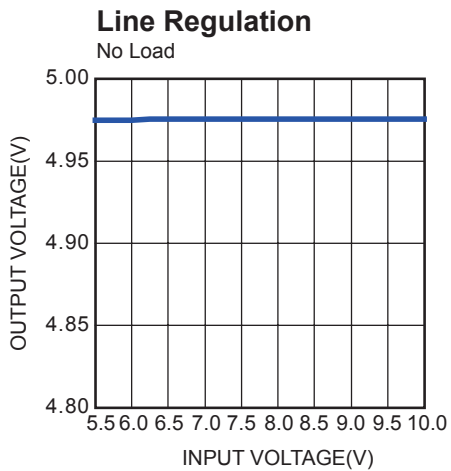
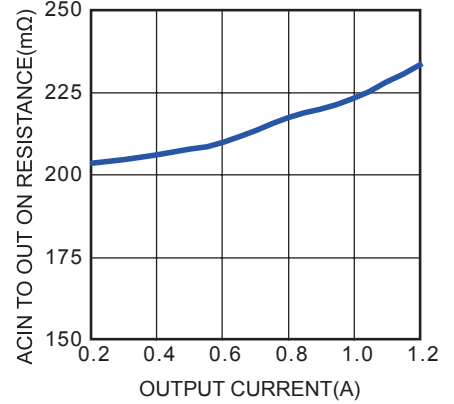
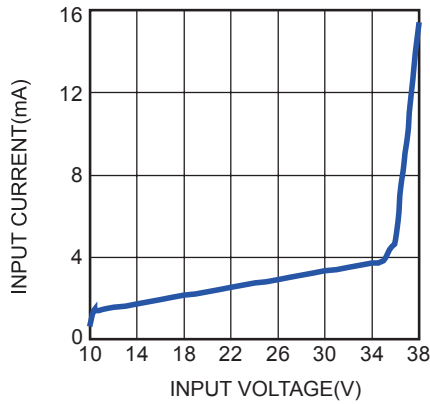
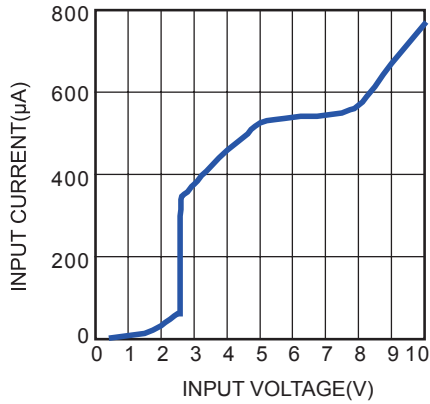

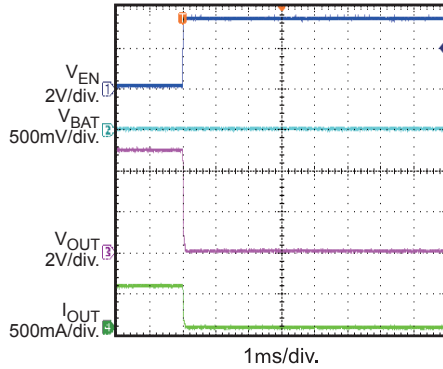
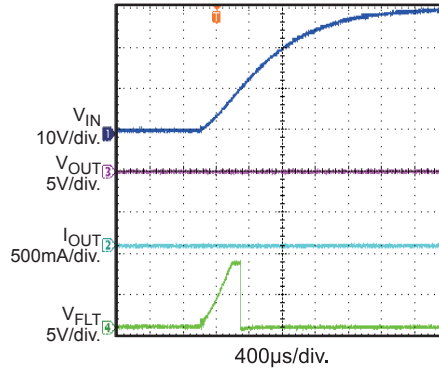
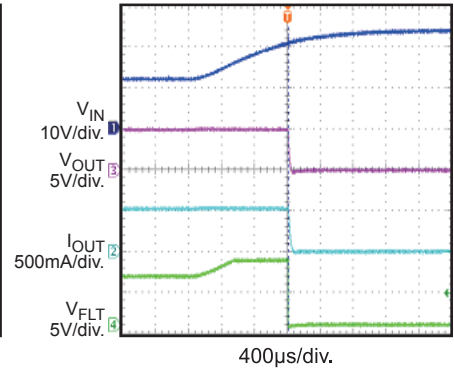
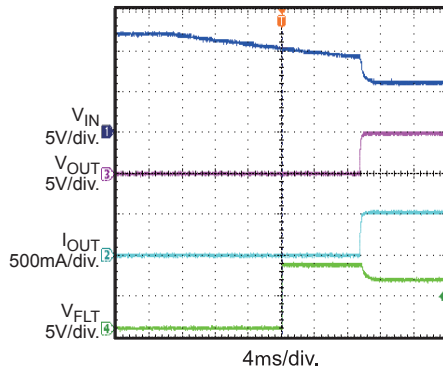
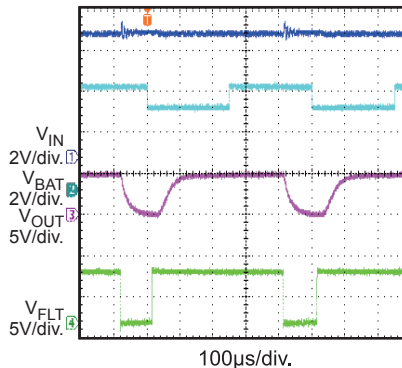
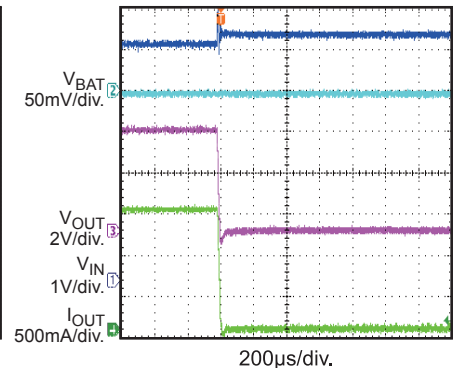
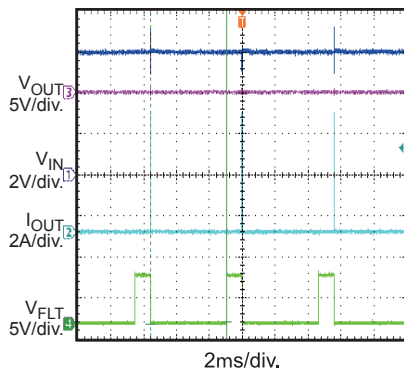
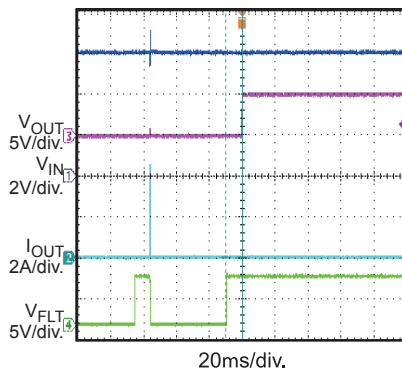
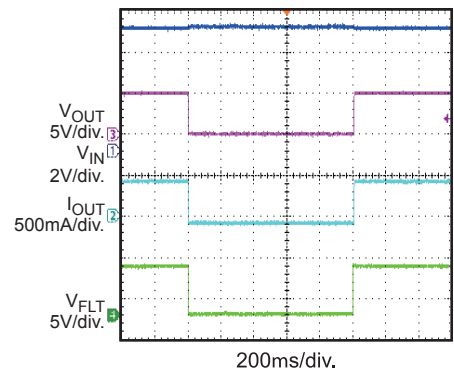
TYPICAL PERFORMANCE CHARACTERISTICS (continued)
 $V_{IN}=6V$, $V_{BAT}=GND$, $R_{VB}=10k\Omega$, $R_{FLT}=6.04k\Omega$, $C_{IN}=1\mu F$, $C_{OUT}=1\mu F$, $T_A=25^{\circ}C$, unless otherwise noted.
En Off
 $R_{OUT}=10\Omega$

Input OVP Start Up
 V_{IN} jumps from 0V to 30V
 $R_{OUT}=10\Omega$

Input OVP
 V_{IN} steps from 6V to 12V
 $R_{OUT}=10\Omega$

Input OVP Recovery
 V_{IN} drops from 12V to 6V
 $R_{OUT}=10\Omega$

Battery OVP
 V_{BAT} switches between 4V and 5V
 $R_{OUT}=10\Omega$

OCP
Increase I_{OUT} to OCP point
after input start up

SCP
Short the OUT to GND

SCP Recovery
Remove the short wire

OTP
Increase T_A till the part shuts down
 $R_{OUT}=10\Omega$

FUNCTIONAL BLOCK DIAGRAM

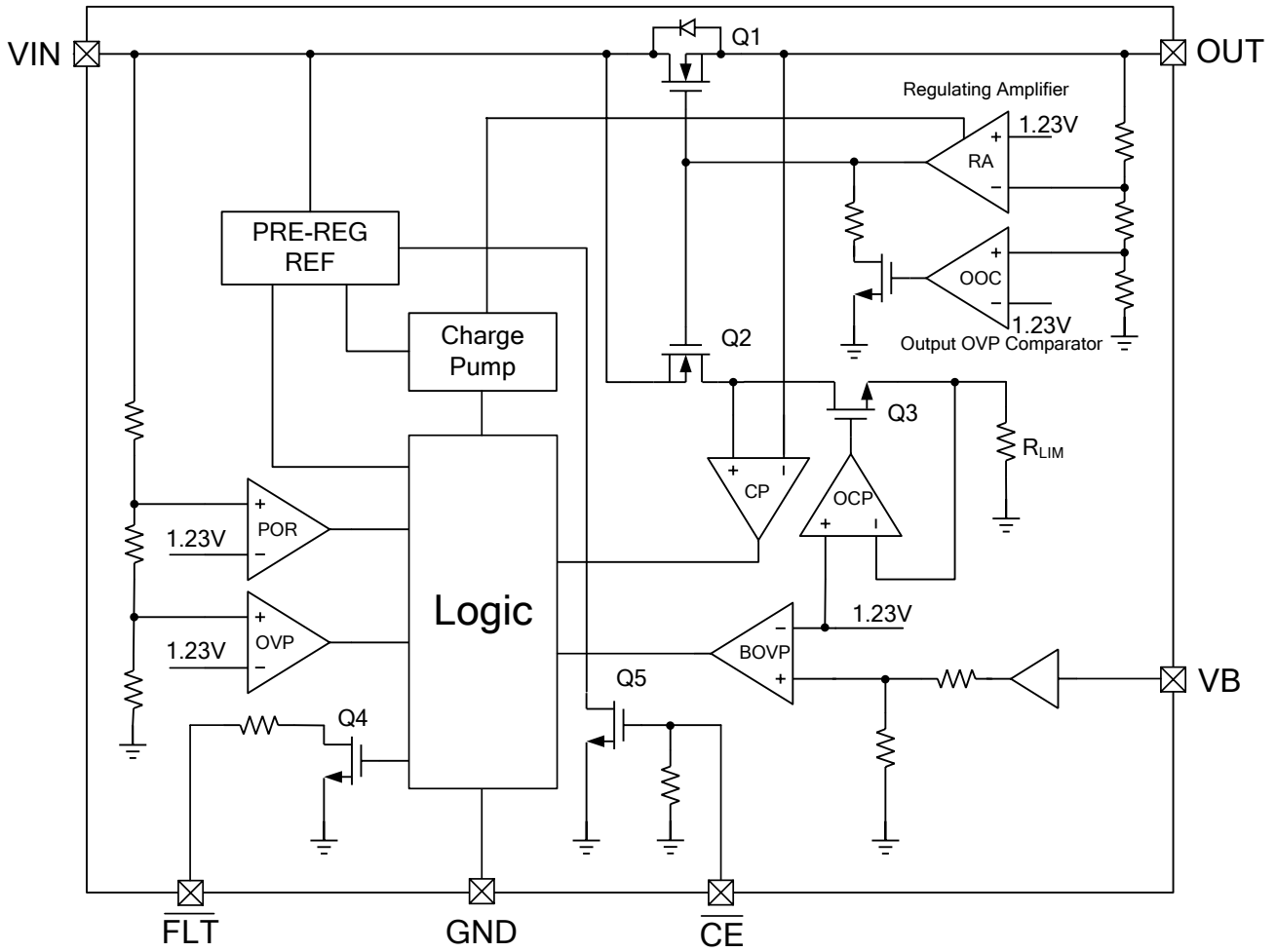

Figure 1-Block Diagram

OPERATION

The MP2678 is a high performance single cell Li-Ion/Li-Polymer battery charger protection IC. By integrating the high voltage input protection, the MP2678 can tolerate an input surge up to +30V.

The device operates like a linear regulator, maintaining a 5V output with the input voltage up to the over voltage protection threshold.

MP2678 features input over voltage protection (OVP), battery over voltage protection (BOVP) and over current protection (OCP). When any fault condition happens, the IC will immediately turn off the internal N-MOSFET disconnecting the charging circuit from the input.

For guaranteed safe operation, the MP2678 monitors its own internal temperature and turns off the N-MOSFET bridging VIN and OUT when the die temperature exceeds 140°C.

The device also provides fault indication to the system when any of the protection events happens.

Power On Reset

The MP2678 has a power-on reset (POR) threshold of 2.8V with a built-in hysteresis of 150mV. When the input voltage is below the POR threshold, the internal N-MOSFET is off. The IC resets itself and waits for approximately 8ms after the input voltage exceeds the POR threshold, then, if the input voltage and battery voltage are safe, the IC begins to turn on the internal N-MOSFET. The 8ms delay allows any transient at the input during a hot insertion of the power supply to settle down before the IC starts to operate.

Input Voltage Protection

The input voltage is continuously monitored by internal comparator. When the input voltage exceeds the threshold V_{OVP} , the internal N-MOSFET will be turn off within 1 μ s to prevent the high input voltage from damaging the electronics in the handheld system. The hysteresis for the input OVP threshold is given in the Electrical Specification. When the input over-voltage condition is removed, the internal N-MOSFET is turned on again. Because of the 8ms delay before the start, the output is never

enabled if the input rises above the OVP threshold quickly.

Battery Over-Voltage Protection

The battery voltage OVP threshold is internally set to 4.35V. The threshold has 150mV built-in hysteresis. The battery voltage is monitored via the VB pin and issues an over-voltage signal to turn off the internal N-MOSFET when the battery voltage exceeds the battery OVP threshold. The internal comparator has a built-in 176 μ s blanking time to prevent any transient voltage from triggering the OVP. If the OVP situation still exists after the blanking time, the power FET is turned off.

Over-Current Protection

The current in the internal N-MOSFET is limited to prevent charging the battery with an excessive current. The OCP threshold is preset at 1.5A. When OCP happens, \overline{FLT} pin is pulled low and the $t_{REC(OCP)}$ timer begins, once the $t_{REC(OCP)}$ timer expires, \overline{FLT} becomes high impedance and the part restarts again after 8ms delay..

Thermal Protection

The MP2678 monitors its own die temperature to prevent any thermal failure. When the internal temperature reaches 140°C, the internal N-MOSFET is turned off and the \overline{FLT} pin is pulled low. The IC does not resume operation until the internal temperature drops below 120°C.

EN Function

The IC has an active-low \overline{CE} pin used to enable and disable the device. Connect the \overline{CE} pin high to turn off the internal N-MOSFET. Connect the \overline{CE} pin low to turn on the internal N-MOSFET and enter the start-up routine. The \overline{CE} pin has an internal pull down resistor and can be left unconnected.

Fault Indication

The $\overline{\text{FLT}}$ pin is an open-drain output that indicates a LOW signal when any of the four protection events happens:

1. Output short-circuit
2. Input over-voltage
3. Battery over-voltage
4. Thermal protection

The $\overline{\text{FLT}}$ pin is high impedance when the $\overline{\text{CE}}$ pin is high.

APPLICATION INFORMATION

For safe and effective charging, some strict requirements have to be satisfied during charging Li-Ion batteries such as high precise power source for charging (4.2V±50mV) the accuracy should be higher than 1%. For highly used capacity, the voltage of the battery should be charged to the value (4.2V) as possible as could. Otherwise, the performance and the life of the battery suffers overcharge. Additionally, the pre-charge for depleted batteries, charging voltage, charging current, as well as the temperature detection and protection, are required for linear battery chargers. The output of most MPS linear chargers has a typical I-V curve and provides overcharge, input over voltage, over temperature protection. The function of the MP2678 is to add a redundant protection layer such that, under any fault condition, the charging system output does not exceed the I-V limits that the battery required. Additionally, MP2678 provides full protection for these chargers whose protection function is not so complete especially those without input surge voltage sustain. MP2678 guarantees the safety of the charge system with its perfect 4 protection functions: OVP, BOVP, OCP and OTP.

An internal N-MOSFET is used for regulating the output voltage to be constant at 5V with input voltage up to the over voltage protection threshold.

The MP2678 is a simple device that requires few external components, in addition to the linear charger circuit as shown in the Typical Application Circuit. The selection of MP2678's external components is shown as follow.

C_{IN} and C_{OUT} Selection

The input capacitor (C_{IN}) is used for decoupling. Higher value of C_{IN} reduces the voltage drop or the over shoot during transients. The AC adapter is inserted live (hot insertion) and sudden step down of the current may cause the input voltage overshoot. During an input OVP, the N-MOSFET is turned off in less than 1μs and can lead to significant over shoot. Higher capacitance of C_{IN} reduces this type of over shoot. However, the over shoot caused by a hot insertion is not very dependent on the decoupling capacitance value. Usually, the input decoupling capacitor is recommended to

use a dielectric ceramic capacitor with a value between 1μF to 4.7μF.

The output of the MP2678 and the input of the charging circuit typically share one decoupling capacitor C_{OUT}. The selection of that capacitor is mainly determined by the requirement of the charging circuit. When using the MP2602 family chargers, a 1μF to 4.7uF ceramic capacitor is recommended.

R_{VB} Selection

R_{VB} limits the current from the VB pin to the battery terminal in case the MP2678 fails. The recommended value is between 200kΩ to 1MΩ. With 200kΩ resistance, during the failure operation, assuming the VB pin voltage is 30V and the battery voltage is 4.2V. The worst case the current flowing from the VB pin to the charger output is,

$$(30V - 4.2V)/200k\Omega = 130\mu A,$$

Such small current can be easily absorbed by the bias current of other components. Increasing the R_{VB} value reduces the worst case current, but at the same time increases the error for the 4.35V battery OVP threshold.

As the typical VB pin leakage current is 20nA, the error of the battery OVP threshold can be calculated as 4.35V+20nAxR_{VB}. With the 200kΩ resistor, the worst-case additional error is 4mV and with a 1MΩ resistor, the worst-case additional error is 20mV.

R_{FLT} Selection

The pull-up resistor R_{FLT} limits the sink current from the VIN pin to the \overline{FLT} pin when any protection event happens and the \overline{FLT} pin is pulled low. The maximum sink current must not beyond 5mA when the worse case happens. That means the input voltage is 30V. So the R_{FLT} value can be calculated like this:

$$R_{FLT} > 30V/5mA = 6k\Omega$$

The recommended value is between 6kΩ to 200kΩ. While a LED is used to indicate the status, in order to drive the LED, a smaller resistor should be selected such as 6.04kΩ.

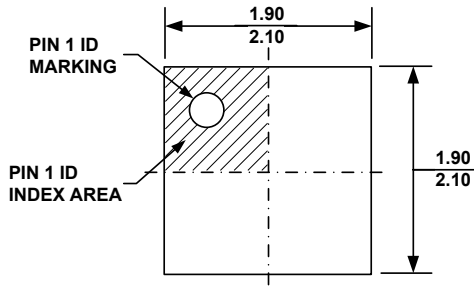
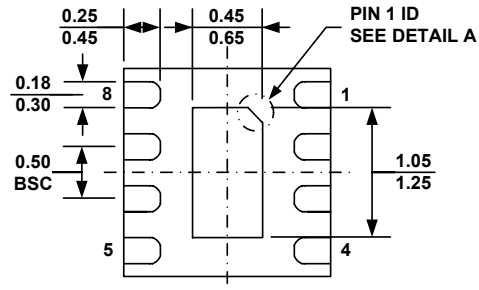
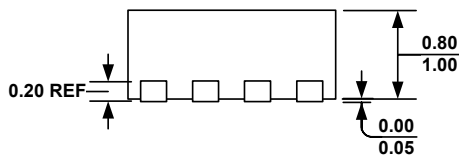
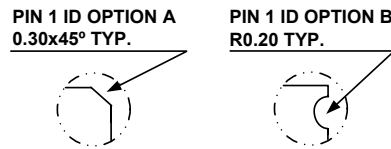
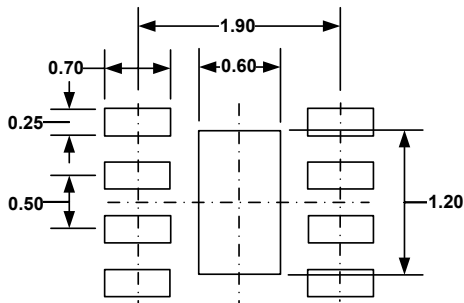
PACKAGE INFORMATION
QFN8 (2mmx2mm)

TOP VIEW

BOTTOM VIEW

SIDE VIEW

DETAIL A

RECOMMENDED LAND PATTERN
NOTE:

- 1) ALL DIMENSIONS ARE IN MILLIMETERS.
- 2) EXPOSED PADDLE SIZE DOES NOT INCLUDE MOLD FLASH.
- 3) LEAD COPLANARITY SHALL BE 0.10 MILLIMETER MAX.
- 4) DRAWING CONFORMS TO JEDEC MO-229, VARIATION VCCD-3.
- 5) DRAWING IS NOT TO SCALE.

NOTICE: The information in this document is subject to change without notice. Please contact MPS for current specifications. Users should warrant and guarantee that third party Intellectual Property rights are not infringed upon when integrating MPS products into any application. MPS will not assume any legal responsibility for any said applications.