



GS2970A 3Gb/s, HD, SD SDI Receiver complete with SMPTE Audio and Video Processing

Key Features

- Operation at 2.97Gb/s, 2.97/1.001Gb/s, 1.485Gb/s, 1.485/1.001Gb/s and 270Mb/s
- Supports SMPTE 425M (Level A and Level B), SMPTE 424M, SMPTE 292M, SMPTE 259M-C and DVB-ASI
- Integrated Reclocker
- Integrated low phase noise VCO
- Serial digital reclocked, or non-reclocked loop-through output
- Integrated audio de-embedder for eight channels of 48kHz audio
- Integrated audio clock generator
- Ancillary data extraction
- Optional conversion from SMPTE 425M Level B to Level A for 1080p 50/60 4:2:2 10-bit inputs
- Parallel data bus selectable as either 20-bit or 10-bit
- Comprehensive error detection and correction features
- Output H, V, F or CEA 861 Timing Signals
- 1.2V digital core power supply, 1.2V and 3.3V analog power supplies, and selectable 1.8V or 3.3V I/O power supply
- GSPI Host Interface
- Wide temperature range of -40°C to +85°C
- Low power operation (typically 350 mW)
- Small 11mm x 11mm 100-ball BGA package
- Pb-free and RoHS compliant

Applications

Application: Single Link (3G-SDI) to Dual Link (HD-SDI) Converter

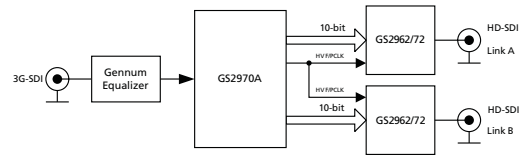

Application: 1080p50/60 Monitor

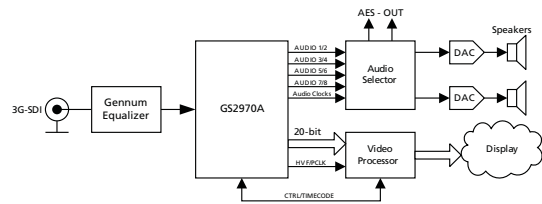

Application: Multi-format Downconverter

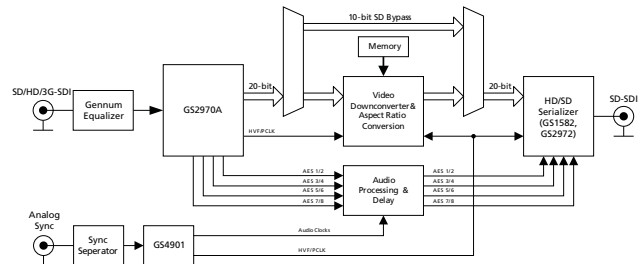

Application: Multi-input Video Monitoring System

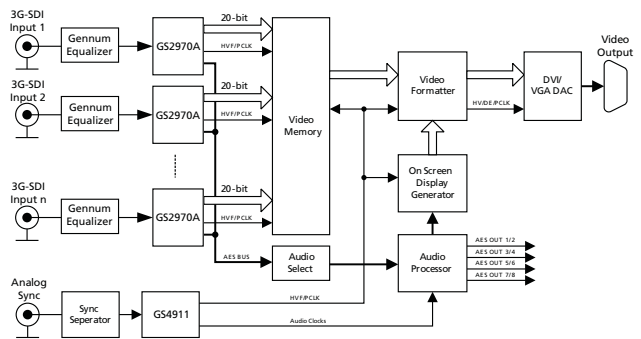

Application: Multi-format Audio De-embedder Module

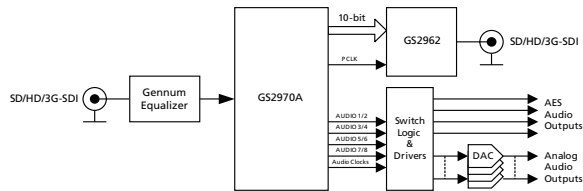

Application: Multi-format Digital VTR/Video Server

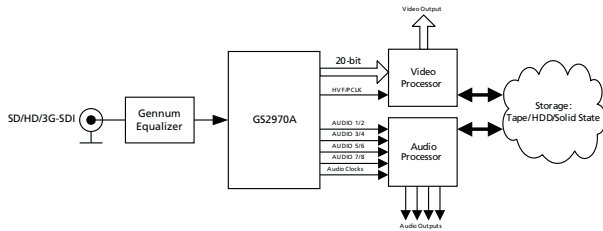

Description

The GS2970A is a multi-rate SDI Receiver which includes complete SMPTE processing, as per SMPTE 425M, 292M and SMPTE 259M-C. The SMPTE processing features can be bypassed to support signals with other coding schemes.

The device features an Integrated Reclocker with an internal VCO and a wide Input Jitter Tolerance (IJT) of 0.7UI.

A serial digital loop through output is provided, which can be configured to output either reclocked or non-reclocked serial digital data. The serial digital output can be connected to an external cable driver.

The device operates in one of four basic modes: SMPTE mode, DVB-ASI mode, Data-Through mode or Standby mode.

In SMPTE mode (the default operating mode), the GS2970A performs full SMPTE processing, and features a number of data integrity checks and measurement capabilities.

The device also supports ancillary data extraction, and can provide entire ancillary data packets through host-accessible registers. It also provides a variety of other packet detection and error handling features. All of these processing features are optional, and may be individually enabled or disabled through register programming.

Both SMPTE 425M Level A and Level B inputs are supported with optional conversion from Level B to Level A for 1080p 50/59.94/60 4:2:2 10-bit inputs.

In DVB-ASI mode, sync word detection, alignment and 8b/10b decoding is applied to the received data stream.

In Data-Through mode, all forms of SMPTE and DVB-ASI decoding are disabled, and the device can be used as a simple serial to parallel converter.

The device can also be placed in a lower power Standby mode. In this mode, no signal processing is carried out and the parallel output is held static.

Parallel data outputs are provided in 20-bit or 10-bit format for 3Gb/s, HD and SD video rates, with a variety of mapping options. As such, this parallel bus can interface directly with video processor ICs, and output data can be multiplexed onto 10 bits for a low pin count interface.

Up to eight channels (two audio groups) of serial digital audio may be extracted from the video data stream, in accordance with SMPTE 272M-C and SMPTE 299M.

The output audio formats supported by the device include AES/EBU and I²C, and two other industry standard serial digital formats. A variety of audio processing features are provided to ease implementation. Audio clocks are internally generated and provided by the device.

Functional Block Diagram

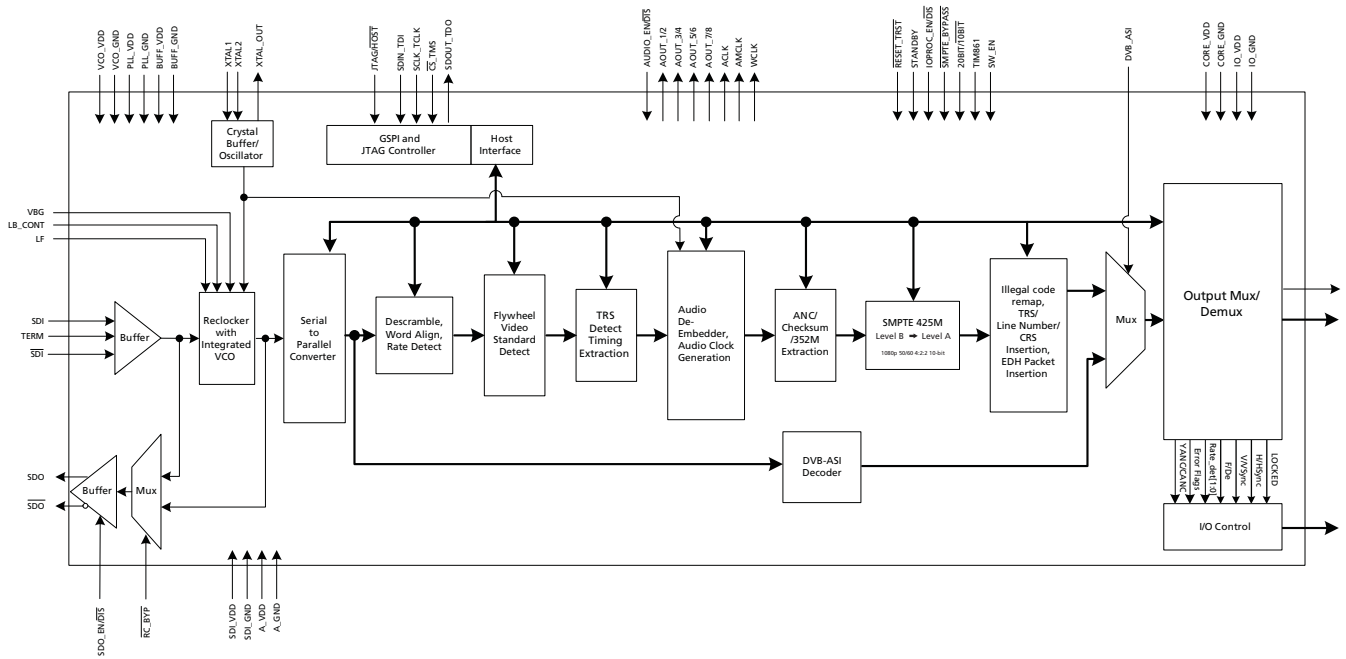

GS2970A Functional Block Diagram

DOCUMENT IDENTIFICATION
PRODUCT BRIEF

The product is in a development phase and specifications are subject to change without notice. Gennum reserves the right to remove the product at any time. Listing the product does not constitute an offer for sale.

CAUTION

ELECTROSTATIC SENSITIVE DEVICES
DO NOT OPEN PACKAGES OR HANDLE EXCEPT AT A
STATIC-FREE WORKSTATION



GENNUM CORPORATE HEADQUARTERS

4281 Harvester Road, Burlington, Ontario L7L 5M4 Canada

Phone: +1 (905) 632-2996

E-mail: corporate@gennum.com

Fax: +1 (905) 632-2055

www.gennum.com

OTTAWA

232 Herzberg Road, Suite 101
Kanata, Ontario K2K 2A1
Canada

Phone: +1 (613) 270-0458

Fax: +1 (613) 270-0429

CALGARY

3553 - 31st St. N.W., Suite 320
Calgary, Alberta T2L 2K7
Canada

Phone: +1 (403) 284-2672

UNITED KINGDOM

South Building, Walden Court
Parsonage Lane,
Bishop's Stortford Hertfordshire, CM23 5DB
United Kingdom

Phone: +44 1279 714170

Fax: +44 1279 714171

INDIA

#208(A), Nirmala Plaza,
Airport Road, Forest Park Square
Bhubaneswar 751009
India

Phone: +91 (674) 653-4815

Fax: +91 (674) 259-5733

SNOWBUSH IP - A DIVISION OF GENNUM

439 University Ave. Suite 1700
Toronto, Ontario M5G 1Y8
Canada

Phone: +1 (416) 925-5643

Fax: +1 (416) 925-0581

E-mail: sales@snowbush.com

Web Site: <http://www.snowbush.com>

MEXICO

288-A Paseo de Maravillas
Jesus Ma., Aguascalientes
Mexico 20900

Phone: +1 (416) 848-0328

JAPAN KK

Shinjuku Green Tower Building 27F
6-14-1, Nishi Shinjuku
Shinjuku-ku, Tokyo, 160-0023
Japan

Phone: +81 (03) 3349-5501

Fax: +81 (03) 3349-5505

E-mail: gennum-japan@gennum.com

Web Site: <http://www.gennum.co.jp>

TAIWAN

6F-4, No.51, Sec.2, Keelung Rd.
Sinyi District, Taipei City 11502
Taiwan R.O.C.

Phone: (886) 2-8732-8879

Fax: (886) 2-8732-8870

E-mail: gennum-taiwan@gennum.com

GERMANY

Hainbuchenstraße 2
80935 Muenchen (Munich), Germany

Phone: +49-89-35831696

Fax: +49-89-35804653

E-mail: gennum-germany@gennum.com

NORTH AMERICA WESTERN REGION

691 South Milpitas Blvd., Suite #200
Milpitas, CA 95035
United States

Phone: +1 (408) 934-1301

Fax: +1 (408) 934-1029

E-mail: naw_sales@gennum.com

NORTH AMERICA EASTERN REGION

4281 Harvester Road
Burlington, Ontario L7L 5M4
Canada

Phone: +1 (905) 632-2996

Fax: +1 (905) 632-2055

E-mail: nae_sales@gennum.com

Gennum Corporation assumes no liability for any errors or omissions in this document, or for the use of the circuits or devices described herein. The sale of the circuit or device described herein does not imply any patent license, and Gennum makes no representation that the circuit or device is free from patent infringement.

All other trademarks mentioned are the properties of their respective owners.

GENNUM and the Gennum logo are registered trademarks of Gennum Corporation.

© Copyright 2010 Gennum Corporation. All rights reserved.

www.gennum.com
